

**BRITISH SCHOOL OF ARCHAEOLOGY
IN EGYPT**

**AND EGYPTIAN RESEARCH ACCOUNT
FIFTEENTH YEAR, 1909**

QURNEH

BY

W. M. FLINDERS PETRIE

WITH A CHAPTER BY

J. H. WALKER

LONDON

SCHOOL OF ARCHAEOLOGY IN EGYPT
UNIVERSITY COLLEGE, GOWER STREET, W.C.

AND

BERNARD QUARITCH
11, GRAFTON STREET, NEW BOND STREET, W.

1909

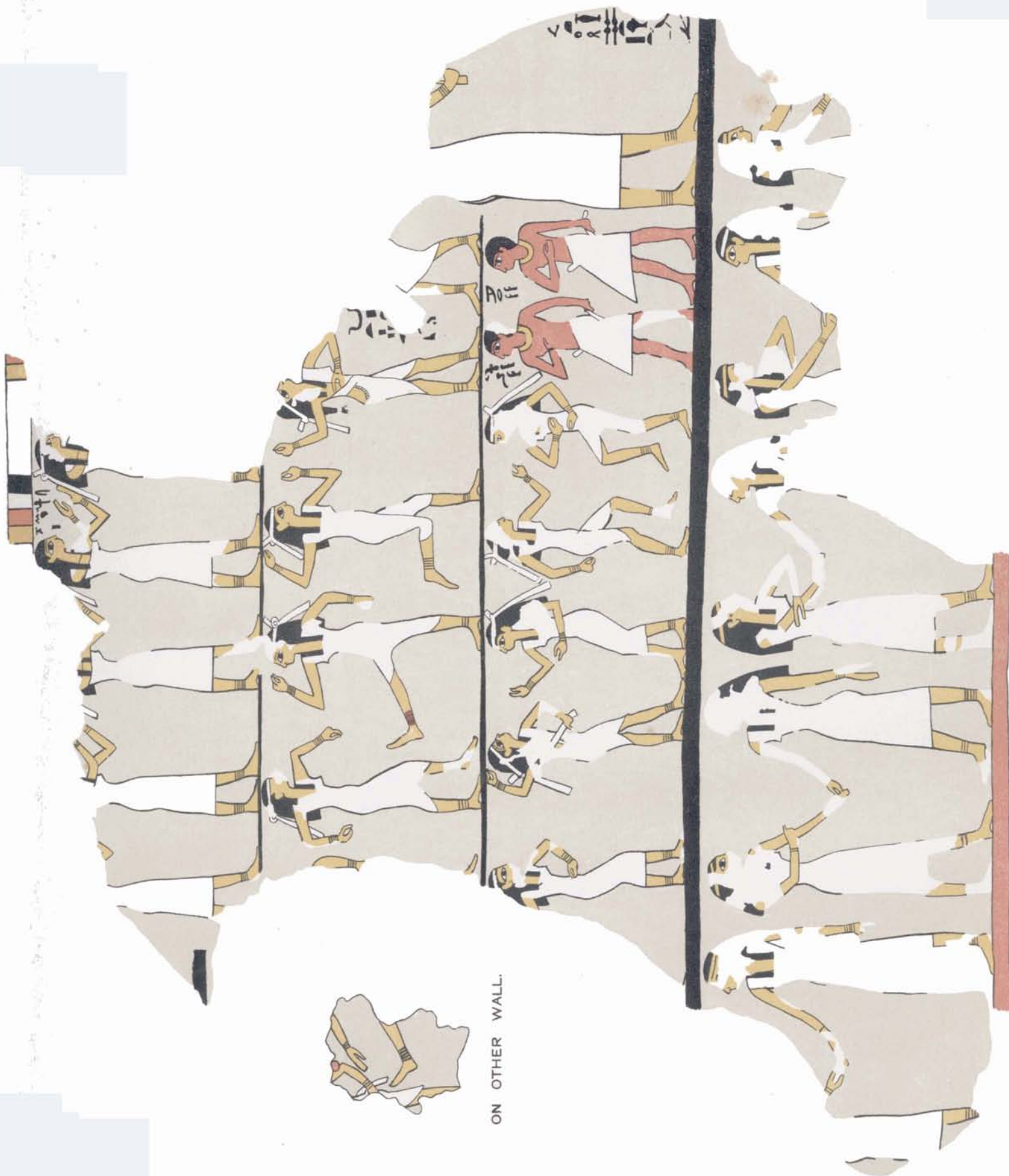

ON OTHER WALL.

BRITISH SCHOOL OF ARCHAEOLOGY IN EGYPT
AND EGYPTIAN RESEARCH ACCOUNT
FIFTEENTH YEAR, 1909

Q U R N E H

BY

W. M. FLINDERS PETRIE

HON. D.C.L., LL.D., LITT.D., PH.D.
F.R.S., F.B.A., HON. F.S.A. (SCOT.)
MEMBER OF THE ROYAL IRISH ACADEMY
MEMBER OF THE IMPERIAL GERMAN ARCHAEOLOGICAL INSTITUTE
CORRESPONDING MEMBER OF THE SOCIETY OF ANTHROPOLOGY, BERLIN
MEMBER OF THE ROMAN SOCIETY OF ANTHROPOLOGY
MEMBER OF THE SOCIETY OF NORTHERN ANTIQUARIES
MEMBER OF THE AMERICAN PHILOSOPHICAL SOCIETY
EDWARDS PROFESSOR OF EGYPTOLOGY, UNIVERSITY OF LONDON

WITH A CHAPTER BY
DR. J. H. WALKER

LONDON
SCHOOL OF ARCHAEOLOGY IN EGYPT
UNIVERSITY COLLEGE, GOWER STREET, W.C.
AND
BERNARD QUARITCH
11, GRAFTON STREET, NEW BOND STREET, W.

1909

PRINTED BY
HAZELL, WATSON AND VINEY, LD.,
LONDON AND AYLESBURY.

BRITISH SCHOOL OF ARCHAEOLOGY IN EGYPT, AND EGYPTIAN RESEARCH ACCOUNT

Patron:

THE EARL OF CROMER, G.C.B., G.C.M.G., K.C.S.I., Etc., Etc.

*GENERAL COMMITTEE (*Executive Members)*

LORD AVEBURY	*Prof. ERNEST GARDNER	Sir C. SCOTT MONCRIEFF
WALTER BAILY	Prof. PERCY GARDNER	ROBERT MOND
HENRY BALFOUR	Rt. Hon. Sir G. T. GOLDIE	Prof. MONTAGUE
FREIHERR VON BISSING	Prof. GOWLAND	WALTER MORRISON
Dr. T. G. BONNEY	Mrs. J. R. GREEN	*Miss M. A. MURRAY
Rt. Hon. JAMES BRYCE	Dr. A. C. HADDON	Prof. P. E. NEWBERRY
Prof. J. B. BURY	JESSE HAWORTH	Dr. PAGE MAY
*SOMERS CLARKE	Dr. A. C. HEADLAM	F. W. PERCIVAL
EDWARD CLODD	*Sir ROBERT HENSLEY (<i>Chairman</i>)	Dr. PINCHES
W. E. CRUM	D. G. HOGARTH	Dr. G. W. PROTHERO
Prof. BOYD DAWKINS	Sir H. H. HOWORTH	Dr. G. REISNER
Prof. S. DILL	Baron A. VON HÜGEL	Sir W. RICHMOND
*Miss ECKENSTEIN	Prof. MACALISTER	Prof. F. W. RIDGEWAY
Dr. GREGORY FOSTER	Dr. R. W. MACAN	Mrs. STRONG
Dr. J. G. FRAZER	Prof. MAHAFFY	Mrs. TIRARD
ALAN GARDINER	*J. G. MILNE	E. TOWRY WHYTE

Treasurer—*H. SEFTON-JONES

Honorary Director—Prof. FLINDERS PETRIE

Honorary Secretaries—Mrs. HILDA PETRIE and *Dr. J. H. WALKER.

The need of providing for the training of students is even greater in Egypt than it is in Greece and Italy; and the relation of England to Egypt at present makes it the more suitable that support should be given to a British School in that land. This body is the only such agency, and is also the basis of the excavations of Prof. Flinders Petrie, who has had many students associated with his work in past years. The great enterprise of the excavation of the temples and city of Memphis, which has now been undertaken, promises the most valuable results. But it will necessarily be far more costly than any other work in Egypt, and it cannot be suitably carried out without increasing the present income of the School. Active support is required to ensure the continuance of such work, which depends entirely on personal contributions, and each subscriber receives the annual volume. The antiquities not retained by the Egyptian Government are presented to Public Museums, after the Annual Exhibition, during July, at University College. The accounts are audited by a Chartered Accountant, and published in the Annual Report. Treasurer: H. SEFTON-JONES.

ADDRESS THE HON. SECRETARY,

BRITISH SCHOOL IN EGYPT, UNIVERSITY COLLEGE,

GOWER STREET, LONDON, W.C.

CONTENTS

INTRODUCTION

SECT.	PAGE
1. Conditions of the work	1
2. The hills and valleys	1
3. The working staff	2

CHAPTER I

THE ANTEF CEMETERY.

4. Age of the cemeteries	2
5. The tombs and skulls	2
6. Beads and small objects	3
7. Comparisons of pottery	3

CHAPTER II

THE CHAPEL OF SANKH-KA-RA.

8. The position	4
9. The chapel	5
10. The inscriptions	5
11. The <i>Sed</i> festival	5

CHAPTER III

THE INTACT BURIAL OF THE XVIITH DYNASTY.

12. The position	6
13. The pottery in nets	6
14. The furniture.	7
15. The basket and contents	7
16. The coffin and mummy	7
17. The wrappings	8
18. The jewellery	9
19. The skeleton	10
20. The infant burial	10

INDEX	19
-----------------	----

CHAPTER IV

THE PAINTED TOMBS.

SECT.	PAGE
21. The Dancer's tomb	10
22. Tomb of Baka	11
23. Tomb of Amen-mes	11
24. Tomb of Piaay	11

CHAPTER V

THE XVIIITH AND XIXTH DYNASTIES.

25. Statuettes	12
26. Burials under temple of Nebunnef	12
27. Pottery	12
28. Sculptures of Sety I	13
29. Seals of Sety I	13
30. Temple of Nebunnef	14
31. Squared drawings	14

CHAPTER VI

THE LATER PERIODS.

32. Pottery of XXI nd dynasty	15
33. Coffins of XXV th dynasty	15
34. Late inscriptions	15
35. Pottery of XXVI th dynasty	16

CHAPTER VII

THE INSCRIPTIONS.

By Dr. J. H. WALKER.

36. Discussion of steles	16
37. The Antef steles	16
38. Other XI th dynasty steles	17
39. The statuette of Usi	17

LIST OF PLATES

WITH PAGE REFERENCES TO THE DESCRIPTIONS

		PAGE			PAGE
I.	Frontispiece, Sit - hathor tomb : dancers	11	XXIX.	Jewellery of XVIIth dynasty	9
II.	Steles of Zara	3	XXX.	Inscriptions, XVIIth — XVIIIth dynasties	10, 12
III.	Steles of Zara	3, 16, 17	XXXI.	Objects from tombs	3, 12
IV.	Plan of valleys	1, 4	XXXII.	Figure of Usi	12, 17
V.	Views of Sankh-ka-ra chapel	5	XXXIII.	Figure and foundation deposits	12, 14
VI.	Plan " "	5	XXXIV.	Tomb of Baka, piper	11
VII.	Sed-heb cenotaph	5	XXXV.	" " weighing	11
VIII.	Stone vases, small plans	3, 14, 15	XXXVI.	" " wine and ducks	11
IX.	Pottery, alabaster and stone mauls	3	XXXVII.	" " birds and Taro	11
X.	Pieces of steles, XIth dynasty	17	XXXVIII.	Tomb of Amen-mes	11
XI.	Plans of tombs, XIth dynasty	3	XXXIX.	Tomb of Piaay	11
XII.	Beads, inscriptions, etc.	3, 12	XL.	Groups of pottery, 632-667	12, 13
XIII.	Pottery of Uah-ankh Antef	2, 4	XLI.	Pottery of XVIIth dynasty, 668-710	12
XIV.	Pottery of XIth dynasty, 29-158	4	XLII.	" " " 711-757	12
XV.	" " 159-262	4	XLIII.	Temple of Sety. Rameses I	13
XVI.	" " 263-361	4	XLIV.	" " standards	13
XVII.	" " 362-418	4	XLV.	" " Siptah, etc.	13
XVIII.	" " 419-479	4	XLVI.	" " sealings	13, 14
XIX.	" " 480-553	4	XLVII.	Nebunnef temple plan	14
XX.	" " 554-608	2, 4, 12	XLVIII.	Squared drawings	15
XXI.	" " 609-631	4	XLIX.	Pottery of XXIInd dynasty, 758-785	15
XXII.	Intact burial of XVIIth dynasty	6	L.	" " " 786-797	15
XXIII.	Views of burial " "	6, 7, 8	LI.	" " " 798-811	15
XXIV.	Views of pottery in nets, XVIIth dynasty	6	LII.	Coffins of XXVth dynasty	15
XXV.	Objects from burial, XVIIth dynasty	7, 8	LIII.	Burial, XXVth dynasty. Soul- houses, etc.	15
XXVI.	Objects from burial " "	7, 8, 10	LIV.	Pottery of XXVIth dynasty, 814-850	16
XXVII.	Pottery in nets " "	6, 7, 8	LV.	" " " 851-857	16
XXVIII.	Pottery in nets " "	6, 8	LVI.	Apries tablet. Coptic jar	15

QURNEH

INTRODUCTION

1. THE work of the earlier part of the season was at Qurneh, the northern end of the cemetery of Thebes on the western side. It was carried on from 9 December 1908 to 8 February 1909, after which the workmen from Quft were moved down to Memphis, to continue the work there in the dry end of the season. On such a site as Qurneh a short spell of work could not achieve any large systematic clearance. The main subject was a search in some of the desert valleys for the possible discovery of any remote tombs. Two small valleys were searched; one by trenching the whole of the likely surfaces, with the result of finding one fine interment of the XVIIth dynasty; the other valley was cleared deep and wide over the most promising parts without any result. Another complete work was the clearing of a new temple site of the XIXth dynasty. An important discovery at the close of the time was the *Sed* festival chapel of Sankh-ka-ra of the XIth dynasty; some more clearance might be made there, but as it is on the top of the mountain three miles away, we only spent two days on it. The northern end of the cemetery in the plain opposite Karnak was searched as long as anything could be found, with the result of getting a large collection of pottery of the XIth dynasty, here published, and an important historical inscription. And a little was done on the Draḥ abul Nega hill, both in copying tombs and finding objects. Most of the ground we touched will not need to be looked at again; but two months' work is as nothing in the exploration of such a site.

2. The structure of the western hills at Thebes is but little known; though thousands of persons visit the Tombs of the Kings, hardly any one has seen the other valleys, and the usual maps do not include them. As this was our district, I made a sketch plan of the valleys, given in Pl. IV. The principal peaks were triangulated from a base in the plain; positions at every half-mile or so were fixed by

compass-bearings to these triangulated points; and then the hillsides were sketched from all these positions. The plan is probably correct to one or two hundred feet in any part over the three miles' extent. The contours are mostly at the abrupt cliff lines which run around the hills (see Pl. V); and the levels of these main hard strata are about 1200 feet, 1000, 750, and a plateau of 300 to 400 feet. These heights, and some others noted on the plan, were taken approximately by the angular height, as reflected in water.

The expression of the plan is by assuming a top left-hand shadow, as from an afternoon sun in the south-west. The cliff lines facing east and north are then in deep shadow, shewn here by thick contours. In looking at the map it should be imagined as a relief model in layers, lighted from the top left. The stream lines, or valley bottoms, are marked by arrows.

The whole structure may be called a horse-shoe basin draining to the east, with a great peak on each side of it. The southern peak is the well-known point above the Theban cemetery; the northern peak is two miles away, that of Sankh-ka-ra. Up the middle of the horse-shoe is a ridge dividing it in two, and up this ridge runs the road to the high desert plateau, a short cut to Farshut, thirty-six miles distant. On the west the tableland is cut off by a great valley about four miles wide, which runs in from the Birket Habu northward; and the Farshut road turns north and skirts round the head of this valley.

Various walls of rough stone have been built to prevent easy access from the sides into the northern valley, and many stone shelters and sentry-walks guard the neck south of Sankh-ka-ra. Another long sentry-go guards the ridge above the Tombs of the Kings from being reached by the Farshut road. At S and S by the path leading up to Sankh-ka-ra are seats of palaeolithic man, smooth clearances on the ground with great numbers of worked flints around.

On many parts of the hills most of the flints have been broken artificially in trying them for tool-making; and the work is clearly palaeolithic. The forts marked at the mouth of the largest valley are small square rooms; the southern is thirteen feet square, the northern twenty-five feet square, outside. The date must be late Roman, as a piece of a ribbed amphora of about the IVth century A.D. was found in a brick: and the sizes of the bricks are too small for earlier dates.

3. The party engaged on this work was four in number. Mr. Mackay was there from the first preliminaries to the end of the packing; I was there during the whole of the excavating; my wife stayed for seven weeks drawing tomb-scenes, temple-scenes, and pottery; and Mr. Wainwright superintended part of the men for a month, after which he did drawings of the foreigners in tombs, and went to Memphis to start some of the work there. As visitors we had Mr. Hatton, and Dr. and Mrs. Seligmann who stayed a fortnight for anthropological enquiries.

CHAPTER I

THE ANTEF CEMETERY.

4. To the north of the stream-bed that runs down from the Tombs of the Kings a low stretch of desert is spread out, containing a cemetery of pit and portico tombs, for about half a mile along the desert edge. This is divided in two by a little channel; the north half we noted as cemetery A, the south half as cemetery B. Besides these there are a few tombs noted as N, from being under the temple of Nebunnef further to the south. As a whole, cemetery A was mostly clear of burials later than the XIth dynasty; while cemetery B had been much re-used in the XXIIInd—XXVIth dynasties.

The range of time of the first use of these cemeteries is so short that not much can be traced of changes in the tombs or the pottery. Regarding the direction of the tombs those in B are nearly all north of east, while in A they are equally north and south of east. Which is the earlier class is indicated by the jars with brims, Nos. 554-96 on Pl. XX, a class which is well known to descend from the Old Kingdom (see *Denderah*), to the XIth dynasty (see *Gizeh and Rifeh* XIII, A to D) and to become extinct in the XIIth dynasty. Now these occur in eight north-east tombs in cemetery B, in four north-east tombs in cemetery A, and in not one south-east

tomb. Hence the north-east direction is the earlier, and half of cemetery A is later than cemetery B. The north-east tombs were reckoned as north, and the south-east as facing east. These differ from the directions at Denderah and Hu, see *Diospolis*, p. 43.

A fixed point is given by the group of pottery on Pl. XIII, which was found in a tomb with the steles naming Uah-ankh Antef. This tomb does not contain any brim jar (554-96), nor any wavy mouths (283-354), nor any kohl pottery (263-82); but we can trace its relation to these distinctive classes. The other tombs with which the Antef group is connected by similar forms are A 7, 12?, 15, 24, 26, 32, 47, 54 and B 5, 8, 12, 14, 26?, 33, 40. Of these tombs three (A 7, 15, 26) also have jars, shewing that such extend to the Antef period. Further, the wavy mouths which are common in the XIIth dynasty are found with the jars (in A 7, 18, 23, 27, 28, 39; B 2, 16, 19, 34), but are only found in two tombs (A 7, B 8) with pottery like the Antef forms. And A 7 is the only tomb in which Antef forms are associated with kohl pottery. Hence we may conclude that brim jars (554-96) extend far beyond the Antef age, that wavy mouths (283-354) were scarcely beginning then, and that kohl pottery (263-82) was probably not earlier than the XIIth dynasty. As more than half the groups of pottery contain wavy mouths, which are scarcely as early as Antef,—and one in six contain kohl pottery, which is certainly later, and probably of the XIIth dynasty,—the general conclusion is that most of these tombs are of the latter half of the XIth and early in the XIIth dynasty. Probably the change of direction to south of east is due to the XIIth dynasty.

5. The form of the tombs with pottery was usually a long pit, with length averaging 90 inches in earlier and 87 in later times, breadth 33 in earlier, 27 in later, depth 108 in earlier and 132 in later times. The classes of earlier and later are separated by the absence or presence of wavy mouths and kohl pottery. These pits had usually a chamber at each end, and the chambers show no difference between the periods, averaging 95 to 97 inches in length and width, and 36 inches in height. Altogether 48 tombs were measured. Only five bodies remained, of which four lay on the left side and one on the right.

Of the skulls, sixty-five were collected and measured; the sex of each was estimated by the appearance. The median dimensions in millimetres are, length (Broca) 183.5 m., 178 f.; breadth max. 135 m., 130 f.; bizygomatic 126.5 m., 121 f.; biauri-

cular 116 m., 112 f.; height (bregma), 138 m., 130.5 f.; basi-nasal 101.5 m., 97 f.; basi-alveolar 98.5 m., 94.5 f.; nasi-alveolar 69.5 m., 65.5 f.; nasal height 51 m., 47.5 f.; nasal width 25.5 m., 25 f.; nasi-maxillary height of face 115 m., 111 f.; lower maxillary height to meeting of teeth 40.5 m., 40.2 f.; maxillary length 116 m., 110.5 f.; maxillary breadth low 92.5 m., 92 f., at joint 113.5 m., 109 f. The nasi-maxillary height, from the nasion to the chin, gives the facial height; and the maxillary height gives the position of the mouth. With the bizygomatic breadth, they give the proportions of the face. The height of the jaws, upper and lower, shews no certain difference of sex, only the nasal height affects the greater height of the male face.

Beside the pit tombs with chambers, described above, there were also many portico tombs. A courtyard was cut into the slope of the hard gravel; and then a chamber or a series of chambers was cut into the vertical face, with often a portico of pillars left in front of the chambers. These had nearly all been plundered in various past times, and only in one of these larger tombs was anything found. The tomb No. 2, Pl. XI, had the two Antef steles lying in the doorway, and the pottery Pl. XIII in the chamber itself. The plans, measured and drawn by Mr. Mackay, were selected as the best examples of different types; but the gravel conglomerate is so rough that no precision of measurement is possible. A similar tomb was found at Denderah belonging to the same age, of a man Antefaqer, and published in *Denderah*, Pl. XXXIII.

In these tombs are various types (Pl. XI). (1) A single chamber with a pillar in the middle to support the gravel roof. (2) Two entrances to a corridor, with a passage out of the end of it to a small chamber, in which is the funeral pit. (3) A portico with two pillars, a chamber off the end of it, and a larger chamber at the back of it, with the funeral pit in the corner. (4) A long portico of ten pillars, with a chamber behind it, and a smaller chamber behind that containing the pit. (5) A long gallery with side recesses, one of which contains the pit. (6) A long gallery with side chambers, and a branch from it with other chambers. There is a great variety of the forms, and in some cases there are two or more entrances behind the portico, and secondary porticoes on the other sides of the courtyard. Most of these tombs are so much wrecked and fallen in that the plan is difficult to complete.

The inscriptions found in the cemetery will be

dealt with by Dr. Walker in the last chapter. Here we may note that the two tablets of Zara found together refer separately to his family position and his official position; both allude to the Horus Uahankh Antef. The conquest of Abydos by that king was already known from the royal stele; and we here read that Zara protected the land as far north as Aphroditopolis, fifty miles north of Abydos.

6. The beads and kohl vases found in the cemetery are of early types agreeing with the age of the pottery. We will here note them in groups, according to the pottery that was found with them. In these plates the reference numbers on the right are to A cemetery, and those on the left to B cemetery. With the brim jars, and therefore perhaps of the earlier age, there are the tombs A 6 with the double limestone kohl tube VIII, 27; A 16 with the well-formed alabaster kohl vase VIII, 10; A 19 the spiral beads of large size, VIII, 28, an indigo ball bead, 30, and a sandstone sharpener, 29; B 23 the bird vase of black pottery, XII, 3 (see also Pl. IX), and the beads, XII, 8; lastly B 24 with the alabaster vase VIII, 23. The tombs with jars and also wavy mouths are late XIth or XIIth dynasty, such are A 18 with the alabaster kohl vase VIII, 6, and beads, 7; and B 19 with the rough scarab XII, 15, and beads, 16, 7. The tombs with wavy-mouth vases of late XIth or XIIth dynasty are A 5 with beads XII, 9; B 10 with pink limestone vase VIII, 19; B 20 with rounded alabaster vase VIII, 9, pieces of pottery box with hieratic inscription of Ransenb, and pottery head XXXI, 3, perhaps from a canopic vase; in B 30 was the pottery doll, XXXI, 6; and in B 33 the broken stele Pl. X. The last class of tombs are those with the little drab pottery kohl pots, which are quite disconnected from the Antef tomb, and almost certainly of the XIIth dynasty. These are A 8 with large ball beads and spiral beads, VIII, 17, 18; A 14 with beads XII, 7, and mirror XXXI, 2; A 21 with alabaster vase VIII, 20, beads 22, and sandstone 21; A 31 with pink and grey hard limestone vase, VIII, 4; and A 56 with alabaster vase, and small beads of carnelian and blue glaze, VIII, 1, 2. There is nothing in this last class which is outside of the XIIth dynasty, and some things clearly belong to that time.

7. Next we may note the groups which are not dated by distinctive pottery. A 4 seems to be before the XIth dynasty, perhaps of the VIIIth or IXth, as the carnelian uraeus (XII, 5) is like the Old Kingdom amulets, and likewise the little figure of glaze. The

blue glazed pot, VIII, 12, is also like those made at the close of the Old Kingdom, the alabaster VIII, 11 and bone tool, 13, accompanied it. The rosette scarab of A 15 (XII, 12) inherits the geometric style of the VIth—VIIIth dynasties, but the pottery with it is connected with the Antef group. Apparently of the XIIth dynasty is A 9 with two carnelian beads and pottery, shewn here as a group, 632-6, 637 being apparently of a later burial; also A 33 with characteristic XIIth dynasty vase, beads, and ink-slab, VIII, 14, 15, 16; and probably A 45 is of the same age, XII, 18, 19.

The dating of the pottery we have already considered, but some notes may be added about the plates for easier reference. Pl. XIII gives the best group known for dating the XIth dynasty pottery: it is absolutely fixed to the time of Uah-ankh Antef by the steles found with it, Pls. II, III. On comparing these with the pottery which was approximately dated at Rifeh, Nos. 8-9 are like 97 and 104 Rifeh types, and 19 like 121 Rifeh, there dated as Xth or XIth dynasty; while 14 is like 174 Rifeh and 28 like 177 Rifeh, there dated to XIth or XIIth dynasties (see *Gizeh and Rifeh*, Pls. XIII C, D). Thus the rougher dating before agrees fairly with the precise dating now to Antef. In general the forms which at Rifeh were put to the Xth dynasty 62, 77, 78, may be compared with Nos. 386, 566, 554 here; the forms of the Xth or XIth dynasties, 81, 83, 131, 136, 138 Rifeh, are like Nos. 168, 563, 603, 577, 566 here; and the forms of the XIth or XIIth dynasties, 172, 174, 192, 193 Rifeh, are like Nos. 249, 502, 477, 400 here.

In Pl. XIV the forms of the saucers and bowls are not so distinctive as other types. In Pl. XV the bowls with lips turned down, 161-5, are of the wavy-mouth group of the next plate. The bowls 167-70 belong to the IXth—Xth dynasty style. The class of smooth light red pottery 247-52 is difficult to date; at first it looks like the early XVIIIth dynasty style, but there seems no sufficient reason for double-dating all these tombs. It stands at present quite apart in paste, in colour, and the use of crimson on the top edge. The scabbled patterns on 256-8 are well known in the XIIth dynasty.

In Pl. XVI the little drab kohl pottery, 263-82, is well known in the XIIth dynasty; and it is probably here of that age, as it is detached from the Antef group and from the tombs connected with that. The wavy-mouth forms, 283-354, also belong to the XIIth dynasty, but as they link here to the Antef

group, they probably begin in the XIth. The spouted vases 355-9 are always associated with the previous types, and of the same age. Pl. XVII shews the forms leading in to the globular types. Pl. XVIII is entirely of a class of rough pots which are very common, but varied in details. The higher-shouldered forms are at the top, the most baggy at the bottom, the straightest at the left hand, the most rounded at the right.

Pl. XIX shews the drooping forms, wider at the base. At the bottom are the stands, and a small group from under the Nebunnef temple, N 1, which seems to be of the XIIth dynasty, compare 550 with Rifeh 164. Pl. XX shews the class of brim jars which descend from the Old Kingdom, but are shewn here to extend probably into the XIIth dynasty. The cellular dish 597 is a new form. The type of lid 598 covered with white spots is already known. We now begin the trays of offerings, connected with the soul-houses (see *Gizeh and Rifeh* XIV). Two small groups, N 2, and N 3, are from under the Nebunnef temple. The trays on Pl. XXI are of the roughest forms known. In connection with these we may refer to the photograph, Pl. LIII, of a group of modern soul-houses, piled together by a large stone in the mouth of the valley of the Tombs of the Kings. This stone marks the burial of a holy man, jars of water are put for his refreshment, and soul-houses for his soul to come and rest in. One has even the staircase like the ancient forms. It is very striking to see that the custom of offering model houses for the soul, such as we found at Rifeh of the IXth—XIIth dynasties, is still continued in modern times.

CHAPTER II

THE CHAPEL OF SANKH-KA-RA, XIth DYNASTY.

8. THE mass of hill and valley behind Qurneh is but little known beyond the immediate region of the Tombs of the Kings, and our main purpose was to explore a part of it. On Pl. IV will be seen the general plan of the great denudation valleys which occupy this area. The plan should be viewed as showing the shadows of a relief model in steps, following the main precipices of the cliffs, at about 1200, 1000, 750, and 300 to 400 feet above the plain: the sun is supposed to be in the south-west, at the top left hand, north being to the right hand, as the ground is viewed from the plain. The two leading features of the region are the peaks left one on either

side of the great horse-shoe hollow of denudation. That on the south is the great peak of Thebes above the cemetery; while two miles north of it is an even higher peak marked here as Sankh-ka-ra chapel, and photographed on Pl. V.

Some years ago Dr. Spiegelberg visited the summit, and found brick walls, which he considered to be a temple of Thoth, and by that name it is officially known. Dr. Schweinfurth also ascended it; but all I could hear from residents was that there were some Coptic walls on it. Yet it is by no means inaccessible. From where we lived at Qurneh it is only 25 minutes' walk to the foot, and 45 minutes' climb up the 1200 feet; while returning only takes 50 minutes in all. On going to the top I saw that it was clearly an old Egyptian shrine or small temple, as may be seen by the views given on Pl. V. Accordingly a few workmen were taken up, and the rubbish in the chapel itself was turned over. Besides the chapel I noticed some building behind it, and on a later day we cleared the plan of it, and found two halls each with eight stone bases. Some further clearance in front of the chapel produced nothing.

9. The plan of the chapel is given on Pl. VI. It is a temenos enclosure, 70 feet 3 inches by 80 feet 8 inches over all. Outside of that is a scarp along the two sides, built up of rough stones, to support a platform round the temenos, and a scarp in front with a gangway left in it. Inside the temenos is the chapel, a square block of building with three cells at the back of it. Under the floor-level are low walls of rough stone, with a rather different plan; and in front of the left cell is a step down remaining from over the low wall, plastered and whitened like the general walls and floor. The cells therefore were below the floor-level of the chapel. In the back of the left cell are two niches in the wall where cupboards were probably placed for the deposit of small property. The front of the middle and right cells has been broken away. These low walls before the cells are certainly earlier, and seem as if they had belonged to a preliminary structure.

10. The remains found in the chapel are shown on Pl. VII. There is a long column of royal titles and names of Sankh-ka-ra, which is shewn (by the section at the base) to have projected from a block of limestone. At the side of this is part of a similar column of inscription, adjoining a roll moulding. These show that a large block of limestone was carved with roll moulding down the edges, and narrow pilasters.

Further, pieces were found of what is clearly a sarcophagus lid, well finished outside, roughly hollowed inside, of which the section is in the middle of Pl. VII. Along the curved top were many graffiti, shewn at the side of it; and along the cornice edge and top were other graffiti shewn at the top of the plate. One large flat surface has a graffito, shewn at the left base of the plate. And at the base are also some chips of a small finely cut original inscription. Above this is shewn a fragment of a seated figure, half life-size. It is the knee with the left hand resting on it, and a close-fitting tunic coming down over the wrist.

The presence of many graffiti of successive visitors upon the loose lid shews that it stood where it was accessible, and not in a tomb pit. The name of Senusert shews that it was visited and still complete in the XIIth dynasty. We must then picture a cenotaph or imitation sarcophagus, with roll moulding, pilaster framing, and a separate lid with cornice, standing freely accessible in the chapel, where there is no trace of a well or tomb pit. And along with it was a seated figure in Osiride dress as worn at the Sed festival. The limestone cenotaph was not merely a niche or shrine for the figure, or it would not have had a separate lid, well finished at the joint and rough underneath. That lid proves that a cenotaph sarcophagus existed, the inside of which was invisible.

The column of inscription has first the Horus name, *S-ankh-tau-i-f*, "making his two lands to live"; the vulture-and-uraeus name has not been recovered; the Horus on *nubti* name is *hotep*, not previously known; the throne name Sankh-ka-ra has not been recovered; but the personal name Mentu-hotep is preserved. Probably the fragment of "Hathor lady of . . ." belonged to this column or one similar, as there is no roll at the outer edge of it. There seem to have been adorations to the various gods by Sankh-ka-ra, of which we have fragments to Hathor and Horus.

11. Some years ago I pointed out in *Researches in Sinai* (p. 181) how the *Sed* feast was the Osirification of the king, when his successor was nominated, after which the king reigned as Osiris until his death. This was the modified form of a custom of killing the king at a fixed period, such as is known in modern times both in Africa and India (see Frazer, *Lectures on the Kingship*, 293). The earliest scenes of this feast, before and during the Ist dynasty, shew the king enthroned as Osiris in a shrine and his successor dancing the sacred dance before him;

other men also took part in the dance, which seems to have been held in a curtained enclosure, the emblem of which survived in the three hemi-discs placed behind the king in the dancing scene. The royal daughters were brought to the feast, probably to be married to the successor, who was not the king's son in early times. This Osirification of the king is well known in scenes of Pepy and other early kings, seated clothed in a tunic, covering down to the wrists. The seated figure of a king Mentuhotep clothed in such a tunic was found buried in a pit at Thebes, by Mr. Carter; and this is the Osiride figure of the deified king, buried as deceased at his Sed feast.

Now the seated figure of Sankh-ka-ra here was clothed likewise in the tunic down to the hands. It was an Osiride figure of the deified king. And the cenotaph, or imitation sarcophagus, of which we have verified the lid and inscriptions, would have represented the burial of the human nature of the king, in place of the actual killing and funeral in prehistoric times.

This Sed feast chapel is the first building identified as such; and it provides a suggestive parallel to the frequent occurrence of two pyramids or tombs for a king. Seneferu had two pyramids, Unas had a pyramid and the Mastabat el Faraun, Senusert III had the north brick pyramid at Dahshur in which there is no sign of his burial, and the great sepulchre at Abydos with a granite sarcophagus very skilfully concealed. In these, and other instances, we seem to have the Sed cenotaph and worship of the king, besides his actual burial in another place.

At about a hundred yards behind the chapel, on the flat top of the hill, there stood another block of building, of which the plan is shewn on Pl. VIII. The entrance was on the south side; the two halls, south and north, had each eight columns. As the stone bases are only 19 inches across, it is probable that the columns were of wood. The fact that the columns do not divide the breadth equally, suggests that the space between them was not roofed, but each hall was an atrium open to the sky between the columns. Between the halls there were three chambers, of which the easternmost may have been all in one with the south hall. Along the north side were some benches of brickwork. On the east side of the north hall were some pieces of rough wood and some grass fibre, which seemed to have been parts of bed-frames. About a foot of the walls remains in most parts, varying from an inch or two to a couple of feet.

There is no satisfactory relation of the dimensions of the chapel and the halls. It seems that a cubit of 20·6 inches may have been used in the chapel, and of 21·0 inches in the halls.

CHAPTER III

THE INTACT BURIAL OF THE XVIITH DYNASTY.

12. AFTER trenching closely over much of the sides of the first valley to the north of the road to the Tombs of the Kings, I noticed a projecting face of rock in a retired branch of the valley. This is marked on the plan (Pl. IV), at a little above the zero of the scales, by the letter B. In the ground below this were several natural boulders lying close together. When our men came to clear amongst these they found that they covered a burial, which was placed in an open shallow trench in the rock. The plan of the group is shewn in Pl. XXII. The head was to the west, and the rock scarp overhung the basket side of the group on the south. The rock trench held the coffin and the objects at the sides of it; but the minor coffin, on and beyond the feet, was above the rock cutting. The photographs of the objects in position will shew the general arrangement, Pls. XXIII, XXIV.

13. Beginning on the outer side of the group there was a stick roughly trimmed at the knots, but with the bark on, 50·8 inches long. Upon this ten nets had been slung containing pottery. At the east end were three nets, each containing two pans of thin polished red pottery with black tops (Pl. XXVIII). Next was a long jar in a knotted string bag (Pl. XXVIII), then a long jar in an open net-work (Pl. XXVII). A bare interval on the stick shewed the space where it had been carried on the shoulder. Then came two small pots with the netting much decayed. After two long jars in the ground came a pot turned mouth down, with good netting, another hanging with netting decayed, and a drab pot in netting which had slipped off the end of the stick. All of the nettings were in a very tender state, and only the string bag would bear handling. The gravel was carefully picked away, the dust blown off while holding the net down, and then collodion was dropped over the threads to consolidate them. The entire clearance of this burial occupied about five hours, though in ordinary antiquity digging it would have been rifled in ten minutes. The main part of the interest consisted in these very rare net-works, which

could not be handled without careful preparation on the spot, and would otherwise have perished.

14. Thrust down between the coffin and the rock was the chair (Pl. XXVI.) with the upper side next to the coffin. The four legs were broken off, and thrust down the side of the coffin further to the east. It is evident that the breaking was done violently, at the burial. The chair seat is square, and accurately made, the sides being 17'48, 17'44, 17'47, 17'57 inches, average 17'49, evidently the short cubit. This is not the cubit of $\frac{6}{7}$ of the royal cubit, but of 24 true digits, of .729 inch. The height is also even, being 9'96, 10'00, 10'01 and 10'06 inches, average 10'01. The threading is continuous, passing through 18 holes in each side; 18 threads go through each hole, three bands of three threads each running off to the two diagonals. Each band of three threads passes under three other bands, and then over three, to form the pattern. The legs are stiffened sideways by long angle pieces, or knees, cut out of natural branching of wood.

Between the chair seat and the coffin was a little bowl dropped in on edge, and a pan on edge against the shoulder beyond the chair. These were each full of dried grapes and dates (Pl. XXV). Below the pan were also pieces of bread, shewn in the photograph, and some *dum* nuts, larger than usual, 3'1, 2'6, 2'6 inches long. The larger one has the marks of three teeth in it. At the foot of the small coffin stood an upright jar.

On the south, or further side, were two stool frames, still jointed, but without any of the webbing across. Two turns of webbing left on one side of the larger stool shews it to have been twisted rush; and it seems to have entirely decayed otherwise. The larger, eastern, stool (Pl. XXVI) is $12\frac{1}{2} \times 12$ inches over all, and $5\frac{1}{2}$ high; it had been much used, as the rush twist had deeply ground into the wood, shewing ten lines to the inch. The smaller stool (Pl. XXVI) is 11×10 inches over all, and 4 high. It shews no sign of wear from webbing, and as scraps of linen cloth stuck to one side, it was probably seated with linen. The feet are not at all worn; whereas those of the larger stool are ground down with use, and chips dragged off each foot.

Below the small stool, jammed against the coffin foot, was a box (Pl. XXVI), upside down. It is $15.2 \times 7.3 \times 5.9$ inches high. The lid draws off in dovetail grooves in the usual way; on the end of this lid is a peg, to be lashed to another peg on the box-end, for sealing it up. Inside it is 13.5×5.5 to

5.9 inches. It had contained a large lump of fatty matter, and some clothing pressed in over it. The fat, or ointment, has now soaked into the linen.

15. Next to that was a basket (Pl. XXVI), originally 10 inches across, but now pressed oval; it is 4.8 deep and the lid is 9.0 inches across. The lid was laid in upside down. In it was a horn, a blue marble bowl with monkeys, a bronze cutter, a sharpening stone, two flints and a ball of thread. The horn (Pl. XXV) has the end covered with a plate of ivory which is cemented on, and it therefore was permanently closed. The 8 rays of the pattern are inlaid with slips of ebony, five of which remain. The point has a ring of ivory round it, and upon the end is a bird's head with a spout carved at the top of it. The bird's beak was of black horn, now partly decayed. The neck of the bird was anciently cracked, and has been bound round with a strip of red leather.

The blue marble bowl (Pl. XXV) is 4.8 inches across over all, the mouth 3.8. It has four monkeys around it with outstretched arms. Their tails together form the circle of the base. The marble has a strong fluorescent blue hue inside. The bronze cutter is for cutting out linen, 5.9 inches long. The type is more developed than that of the XIIth dynasty, but not quite so advanced as in the XVIIth. The sharpening stone is 2.4 long, and .9 inch wide at the base. The flint flakes do not look used, and are only roughly struck, and not shaped. The ball of thread is $1\frac{1}{2}$ inches diameter.

Beyond the basket were two small pottery vases (Pl. XXVII), tied down over the tops, and linked together with thread. Behind these was a small upright vase, also of polished red pottery. Near the shoulder was a rough pottery jar standing upright (Pl. XXII).

16. The coffin (Pl. XXIII) is cut out of a single block of wood, and the lid is likewise a single block. The wig is of blue with goldfoil stripes; the forehead, face and breast, goldfoil; the wings, blue feathers with black lines, and gold stripes between. The length over all is 81 inches. Down the middle a formula is stamped by a wooden mould upon the gilded stucco, but no name has been inserted. On the foot end are kneeling figures of Isis and Nebhat mourning.

Inside the coffin lay the mummy, with two large shrouds spread over the whole; each shroud doubled, and then tucked in all round the edge. On removing these, and a bag of bran which lay between them

down the right side, the mummy was seen swathed round spirally with nine turns of cloth from end to end, and with loose blue beads scattered over it. At the right side of the head was an alabaster jar (Pl. XXVII lower) in the corner, resting on the end of a head-rest (Pl. XXV). The head-rest is 12·25 inches long at the base, 6·90 at the top. Its stem is octagonal, each side inlaid with three squares, of ebony and ivory divided diagonally. Lying partly on the head-rest and hanging down the alabaster jar was a bead net-work pouch with handles, as in Pl. XXV. Further down the head at the shoulder was a small basket tied up (Pl. XXVI), and inside it was an alabaster kohl pot tied over with cloth, and the kohl stick put through the tie (Pl. XXVII upper). Near the feet on the left side was a smaller kohl pot of obsidian (Pl. XXV). Beneath the neck was a thin red and black pottery pan (Pl. XXVIII) lying on its side.

Beneath the head lay a second bead pouch with handles and a tassel below (Pl. XXV); both these pouches are of small blue beads. Also 16 strings of long blue beads, 8 inches long, united in a twisted thread handle, apparently a fly whisk (Pl. XXV).

17. The mummy was unwrapped by me, and with the aid of our party of five a record was kept of each separate cloth. The dimensions of the cloths, and of the warp and woof, are here given after the description. Beginning at the outside there was—

- (1) At the feet a roll of very coarse linen with a fringe on the inner end of the piece. Selvedged on each side.
- (2) Remains of ties around the body, made of a tube of linen sewn up; one tube 8 inches, the other 10 inches around, hemmed at ends.
- (3) Shroud folded in two, laid over the body and tucked in around. One selvedge.
- (4) Shroud, similarly placed. One selvedge, one end hemmed.
- (5) Swathing-cloth, spread over head, and then hanked nine times round the body, seven turns downward and two upward from the feet. No selvedges. Seen in Pl. XXIII.
- (6) Cloth under body; edges turned up and lapped one over the other. Folded in four across. One selvedge, one end hemmed.
- (7) Cloth under body; edges turned up roughly. Folded in two across. Selvedge one side, and one end; other end with three stout threads together near rough end.

- (8) Cloth, folded in two across, laid under body, edges roughly turned up, much grease on it. One selvedge, one end hemmed.
- (9) Cloth, folded across in eight, laid under body with edges roughly turned over; grease on it. One selvedge, one edge woven-in fringe.
- (10) Cloth, folded in two along middle lengthways, swathed diagonally round the body. Selvedge end and side.
- (11) Cloth doubled across, under body, edges turned up over. One selvedge side and end.
- (12) Similar to 11.
- (13) Cloth folded lengthways in two, swathed diagonally round the body. One selvedge.
- (14) Cloth folded in two across, laid under body edges folded up, and end tucked up over feet. One side and end selvedge.
- (15) Cloth laid under body, and ends turned up. Too much rotted to measure.

Inside all, the legs were wrapped separately, and the arms, hands, and fingers each wrapped diagonally separately. Pads of small cloths were used, but the whole was so much rotted by insects and decay, and loosened by the decay of all the flesh and shifting of bones, that the exact position could not be seen. Inside the stomach and pelvis was a thick mass of cloth squeezed in tightly, taking a mould of the whole hollow, 10 inches long, 7½ wide, 2½ thick. A large quantity of dark brown dust lay around the bones. The whole skeleton was perfectly preserved, the bones hard and greasy.

The cloths described above measure as follows :—

	Inches.		Threads in inches.	
	Long.	Wide.	Warp.	Woof.
(1)	115	14	21	15
(2)	{ 60 105	{ 8 10	70	38
(3)	176	57	128	56
(4)	171	58	92	38
(5)	189	29	86	62
(6)	328	51	54	27
(7)	164	50	62	35
(8)	166	52	76	40
(9)	711	60	76	40
(10)	141	56	42	25
(11)	164	53	70	62
(12)	170	58	138	40
(13)	283	52	49	32
(14)	182	51	62	38
(15)	rotted		50	35

From these measures we can see that cloths 7 and 14 are probably of one piece, 8 and 9 are of one piece, and 13 and 15 also of one piece. The lengths are even numbers of cubits in many cases; $105 \div 5$; 164 , 164 , $166 \div 8$; $328 \div 16$; shewing a cubit of $20\frac{1}{2}$ to 21 inches. The breadths of 50 to 53 inches which are frequent seem to be $2\frac{1}{2}$ cubits. But it is strange that there is only a single wrapping-cloth with selvages on both sides; all of the others seem to have been reduced by tearing off an edge.

The whole system of the wrapping, from in outwards, seems to have been, swathing of fingers and limbs, two folded-up cloths, a diagonal swathing, two more folded-up cloths, a diagonal swathing, four folded-up cloths, a diagonal swathing, and two loose shrouds over all. There was no sewing up, or neat packing or folding, at any part.

18. Upon the body was a green scarab, with *nofer* in scrolls, tied by string on to the third finger of the left hand. For this and all the jewellery see Pl. XXIX. On each arm, just below the elbow joint, were two plain gold bangles, oval, 2'30 and 2'44 inches wide. Around the waist, outside the innermost cloth, was a girdle of electrum beads, 26 of semicircular form, copied from a disc of leather folded over and stitched; the spaces between these had two threads of six beads each, and in one case a space of seven beads. Three spaces had been gathered together by a tie of thread, so as to shorten the circuit of the girdle to fit the body. The whole girdle was 31'6 inches long, and was shortened to 28'4. Loose about the head were two gold ear-rings or hair-rings, '90 across and '36 inch wide. The four component rings are each made hollow, but not so thin as the later ear-rings of the XVIIIth dynasty.

On the neck was a collar of four rows of small rings of gold. These rings are '17 inch diameter; and thick enough not to collapse when squeezed between the fingers. They are flat on the inside, but rounded or bevelled on the outside. Each has been soldered to join it. The four strings are—

13'1 inches long of 394 rings
14'0 " " " 416 "
14'7 " " " 422 "
15'2 " " " 421 "

varying from $27\frac{1}{2}$ to 30 to the inch, and widening downwards on the slope of the neck. Besides these there is '63 inch width of the junction piece. The junction piece is made of two similar halves. Each

half has four tubes for the ends of the threads. Each tube is made by soldering eight rings together. At the junction ends each tube has a hemispherical cup soldered on to it. Inside each hemisphere is soldered a ring of wire. When the two halves are put together the rings alternate in one line, and are held in unison by a gold pin dropping through all the eight rings. The pin tapers from '04 to '02 near the point; the head is '08 wide; the length is '80 inch. When found, the pin had been put in from below upward by the undertaker; but this was wrong, as it will only go home in the reverse direction. Each of the hemispheres which close the tubes is pierced, doubtless for the master-thread of the stringing to pass through, and be knotted to secure it. A very thick pack of fibre filled the rings; so compact that only two rings could be dragged off at a time, and then the fibre had to be sliced off close before withdrawing more. The fibre was too much rotted to be retained, as the collar could not be straightened or cleaned without its breaking short. The whole was therefore restrung, keeping the original order of the rings.

On the neck of the inner garment was an electrum button. The disc of it is oval, '50 x '37 inch, and very thin. The shank is pointed like a nail; '28 long and '06 inch thick. The edge of the garment was attached to this shank by a cord of threads lashed on to it. It is remarkable that a ring shank was not used, such as is found in the Ist dynasty jewellery, and the VIth dynasty buttons. This looks rather as if it had been an ornamental nail, for decorating woodwork, made to serve for a button.

The weights of the various parts are—

	Grains.
Bangles . . . 322'7, 324'4, 325'6, 325'8 =	1298'5
Girdle	352'
Ear-rings 133'8, 138'8 =	272'6
Strings of rings . 349'4, 364'9, 394'0, 392'6 } =	1585'4
Connecting piece of collar . 39'8, 41'4, 32' }	
Button	11'7
Total	3520'

From the near equality of the bangles it appears that they were carefully weighed. But their weights do not conform to any standard except the 80-grain. This is believed to have been derived from repeated halving of the Assyrian "stone" of 10 shekels, and the total of the 4 bangles is 10 shekels. The bangles then are 4 of 80-grain unit; the collar is 20 of the

unit, and the junction piece is half a unit on each side. The unit varies from 79.3 to 81.5 grains here, and its general limits are 79 to 81 grains. As it was a Syrian unit, it was probably of Hyksos importation in the XVIIth dynasty.

19. The skeleton was in excellent condition, that of a woman in the prime of life. The teeth were but little worn; they are rather projecting, though the face is not prognathous in structure. The arms were down the sides, and the hands on the front of the thighs. The dimensions of the skull were, in millimetres, length 167; breadth max. 132, bizygomatic 121, biauricular 110; height 127; basi-nasal 95, basi-alveolar 92, nasi-alveolar 68; nasal height 49, breadth 23; facial height (nasion to chin) 111; jaw height (to meeting of teeth) 38; jaw length 109; jaw breadth at base 88, at hinge 107. Humeri, R. 289, L. 296. Ulnae, R. 249, L. 248. Femora 412, both. Tibiae, R. 339, L. 338. As compared with average women of the XIth dynasty, the head is short, rather low, but a fair width; the mouth is low in the face; the nose long and narrow, and the jaw rather small in front view. On the whole it is a high type of face, except for the projection and size of the teeth.

As regards the date of the burial, the red polished pottery is most like that of the early XVIIth dynasty, and cannot be placed anywhere near the XIIth. The diagonal pattern of inlay on the headrest is like that on the bead bracelets of Aah-hotep, and the girdle beads like hers, at the end of the XVIIth dynasty. The bronze cutter is later than the XIIth, but not quite as developed as that of the XVIIIth dynasty. The blue marble bowl is like the work of the XIIth; but the kohl pots have the high shoulder of the XVIIIth dynasty. On the whole it might well be placed in the XVIIth dynasty.

20. The burial of an infant was in a box (Pl. XXVI), plain whitewashed, 37.6 inches long, 12 wide, 9½ deep over all. The skull was all but closed at the top, and hence it was not new-born. Over the whole was a cloth 130 × 46 inches, folded to a quarter of the length, and half the breadth, 32 × 23, and tucked in at the sides of the body. Next a cloth 172 × 54, much folded in length and creased to fit the width of the box, and the 54-inch width went over the length of the body, and was tucked in under the head. Then the body was wrapped in about a dozen turns of cloth, but so much decayed and eaten and stuck together that it could not be separated. The limbs were wrapped separately, the

arms were down the sides. On the neck was a thread of 215 small gold ring-beads .05 inch diameter, .42 to the inch; they are only coiled and not soldered. At the right ear was a spoiled group of 3½ gold rings stuck together, looking like a miniature ear-ring, and a similar group at the left. It is evident that some rings like the ring-beads of the woman's necklace but rather larger (.25 wide), had been over-heated while on a mandril in the furnace for soldering; the solder had stuck them together, and they parted and began to drop away, being half melted. On the left humerus were two ivory bangles, 1¾ inch inside width, 2¼ outside, and .15 thick. On the right humerus was one bangle, 1¾ inside, 2 outside width, and .17 thick. Round the waist was a string of small blue ring-beads 19½ inches long, and round each ankle a string of similar beads.

Though this burial was only in the open ground yet it is very complete in personal objects. Probably it is the richest and most detailed undisturbed burial that has been completely recorded and published.

CHAPTER IV

THE PAINTED TOMBS, XVIITH—XXTH DYNASTIES.

21. THE earliest painted tomb that we met with was in a very large rock-pit in the mouth of the small valley at the north end of Drah abul Nega. This pit was about twenty feet square, and had been painted. Only a small part of the fresco remained, on the north side, which is here published as a frontispiece. It had been excavated by some one in recent years. As it was impossible to preserve the fragment of painted wall by any door or reasonable cage over it, I was authorised to remove it, which I did in sections. The work is closely like that of the Isis and Nebhat figures on the foot of the XVIIth dynasty coffin, and it is probably of that age.

The large rock-chamber had originally been self-roofed; but the top had nearly all fallen in. The original entrance was by a brick tunnel about thirty feet long; and, though both ends of the tunnel were broken, there was some probability that the objects in it had been taken out of the tomb when originally plundered. They are all given in Pl. XXXI, 8-15. The cone, 13, is of the hereditary prince, keeper of the temple of Mentu in Erment, named Senmut. This was of course not the celebrated Senmut the architect of Hatshepsut. The kohl vases of black

serpentine, 12, 14, have the sharp shoulder of the XVIIth—XVIIIth dynasties. The fragments of steles, 9, 10, are very rough in lettering, and show that this cannot be dated to the XVIIIth dynasty. The kneeling figure, 11, which originally held a tablet, is of good work, like those of the early XVIIIth dynasty. The bowl, 15, is of the same age.

The fresco (frontispiece) which remained was on the north wall of the chamber, to the west of the door; there were also a few traces of figures to the east of the door. The rock had been roughly flattened, then coated with a layer of mud and straw, and the face of that whitewashed. Upon the yellow-white face the figures were drawn with black for the outlines and hair, yellow for the flesh, white for the dress, and occasionally some red. The top line shows a row of singers beating time with their hands; the name is placed to one of them, Se-ankh-nu. In the second line the women are dancing and snapping their fingers. In the third line is a larger figure, which seems to have been a principal servant with offerings, "made by her praiser Sit-hathor." The dancers are as above, superintended by two men, Uazy and Mery. In the base line are pairs of women holding each other by the hand, probably engaged in a slow dance, as the heel of one is raised from the ground. This is one of the few remains that we have of the rough but spirited archaic work which preceded the rise of the art of the XVIIIth dynasty.

22. An interesting small tomb at the north end of Drah abul Nega belonged to a man Baka and his wife Mes. It is situated in the plain, at the extreme N.E. foot of the hill, facing on the road which skirts the bottom of the slope. It belongs probably to the age of Tahutmes I, as the keeper of the cattle of the deceased queen Aahmes Nefertari is named. The scenes show some good details, though much injured, like other open tombs. My wife copied the less usual subjects, which are here reproduced on Pls. XXXIV to XXXVII.

Pl. XXXIV. A figure of the son of the family, Auab, standing. Behind him is a girl playing double pipes, and another clapping her hands. Above them are jars placed in stands, which may be compared with *Giseh and Rifeh*, Pl. XXVII E, 82.

Pl. XXXV shows two scenes of weighing. In the upper one the weigher is steadying the plumb-bob of the balance to see if it is exact, while the scribe is recording the amount. The stand before

the balance has on it weights of a dome form, and in the shape of a hippopotamus. Compare with this the weight in the form of a hippopotamus head found at Nubt (*Nagada*, p. 67). Below this is another scene, of weighing metal vases, and one of the weights in the scale is in the form of a calf; this form is known on monuments and in actual examples.

Pl. XXXVI. At the top is a scene of storing wine in jars. Below are figures of men who are hauling at a clap-net, while another man seated is cleaning the ducks that were caught, and hanging them up ready for cooking.

Pl. XXXVII gives three separate pieces. A fine goose shews detail of colouring. A beautiful figure of the sister of Baka, named Taro, shews her seated on the ground smelling a lotus. Below is a scene of wildfowl over a thicket of papyrus.

23. The tomb of Amen-mes is toward the northern end of Drah abul Nega, and the connections of it are described at the beginning of the next chapter. It was painted about the time of Amenhotep II; and, though greatly destroyed, it yet contains many fragments of scenes which show that it was of the best work of that age. A few details are given on Pl. XXXVIII. The cylindrical jars used in offering, or placed in stands, are of forms well known at that age. But the "salad-mixer" type of vase in a stand, with papyri between, is fresh to us at this period, and the cups on stands below that are also unusual. The two figures of the tomb front give details of the column, like those of Tell el Amarna tombs, and of the funeral stele placed in a niche in the pyramidion upon the tomb. This latter shows the origin of the so-called window niche in the top of the Meroitic pyramids.

24. Opposite to the tomb of Amen-mes, in the same court, is a later tomb of the keeper of the cattle of Amen in Thebes, Piaay. This is probably of the XXth dynasty, and the colouring is flat and poor. Two parts were selected for copying, here given on Pl. XXXIX. The first scene on the right is of carrying the shrine of Horus in procession, with fans of feathers, and offering incense before it. On the left is the figure of Osiris enthroned, with Isis and Nebhat behind him and the four genii in front of him. Horus comes before him to introduce Piaay (continued in lower line), who is bowing before the god. Next is the scene of weighing the heart, with Piaay and his wife bowing before the weighers. Above this were alternations of the head of Hathor and the name and titles of Piaay.

CHAPTER V

THE XVIIITH AND XIXTH DYNASTIES.

25. THE most important objects of the XVIIIth dynasty were figures found in a tomb pit, anciently plundered, towards the north end of Drah abul Nega. This pit was in a small court, which had the tomb of Amen-mes on the south, that of Piaay standing open on the north, and a plain passage tomb on the west. In the north side of the floor was a small unopened pit and chamber with two burials of the XXVth dynasty, described in the next chapter; and in the north-west corner was a deep tomb pit for which the open court had probably been originally made. In this tomb pit was a seated black granite figure, broken in two pieces and some fragments (Pl. XXXII), and the upper part of a figure in limestone (Pl. XXXIII). The granite figure is of the scribe of the accounts of corn in the southern cities, Usi, son of Si-amen. It is as good as any granite work of the New Kingdom. The limestone figure is of the finest work of that age, with the suavity and beauty which characterise it. Unfortunately it does not bear any inscription.

26. Beneath the temple of Nebunnef the earlier tombs had scarcely been touched in modern times; we were therefore able to obtain some steles, pottery, and other objects. The earliest object is a limestone figure, seated cross-legged, of the king's son Antefmes, called Mes-tesher, the "red child" (XXX, 3). It is decayed by the damp, but interesting from its age. A fragment, XXX, 4, appears to be of a stele of one of the Antefs, Ra-seshes-her-maat or Ra-seshes-up-maat, adoring Amen. A stele of a man and his wife, XXX, 1, appears to be of about the XVIIth dynasty. Half of a black granite base, XXX, 2, was made for the figures of the keeper of the granary of Amen, Setu, and his sister Usi. A piece of limestone with large fine hieroglyphs in relief, XXX, 7, was found in the ruins of the Nebunnef temple; it seems to be part of a tomb of a scribe of accounts. The piece of a black granite sarcophagus, XXX, 5, was bought; it is of the celebrated architect Amenhotep, son of Hapu, whose tomb is as yet unknown. Pieces of steles were also found in the temple of Nebunnef, of Huy, a scribe of Amen, XII, 22; of King Amenhotep I, XII, 23, singularly like Tahutmes III in features; and of a priest Huy adoring Amenhotep and Aahmes Nefertari, XII, 24.

There are also some tomb objects from the same

burial place. The couch and figure of red pottery, XXXI, 5, throw some light on the frequent female figures found in tombs. It has been supposed that they were votive after childbirth, or to represent a wife for the deceased, sometimes with a child. The latter motive is shown here by the couch having a double pillow, but only one figure to lay upon it. These female figures were therefore intended for the benefit of the deceased like the pottery soul-houses, furniture, and food offerings. Probably the so-called dolls, XX, 607, XXXI, 6, 7, were likewise wives. A stone head-rest was found with pottery in another tomb, XX, 604. A brown serpentine vase, XL, 656, was with pottery of the XVIIIth dynasty. And a flask of the black pottery, descended from the prick pattern pottery of Hyksos times, was of the same age, XL, 648. The pottery box-coffin, XL, 654, was in a grave with cones of Khauiy. Similar graves were found under the store-rooms of Sety I. In one of these was a group of hollow silver bangles, much corroded, an alabaster cup, a green paste bowl, and kohl pots of black serpentine and alabaster, XXXI, 16-20. In another grave was a black limestone kohl pot with haematite stick, two cutting-out knives, two needles, and pieces of pyrites and blue glass, XXXI, 22-9.

Pottery cones were often found; those of ten different persons were built into the brick covering over the tomb of the XXVth dynasty, and thirteen others were found in the tombs under the temple of Nebunnef. The names upon these will be published next year, as further work is intended at Qurneh, and more may be discovered.

27. The pottery of the XVIIIth dynasty is shown on Pls. XLI, XLII. The tube pots 678-89 are of the earlier part of the dynasty, as shown by the dating at Rifeh. The blue colouring on 690 shows that it is of Amenhotep II or later. The screw-top pattern 691-2 is of Tahutmes I or earlier, see *Gizeh and Rifeh*, XXVII E, 90, 91. The forms 693-4 are of Tahutmes III, see *Rifeh* 209. No. 696 is probably earlier, see *Rifeh* 190, 192. The succeeding forms to 704 are of Tahutmes III, or a little later, see *Rifeh* 254-5, 325, 349-51. The black bands and red and black 705-10 are also of Tahutmes III, see *Rifeh* 248-50. The well-formed oval bottles 720-6 are of Tahutmes III (*Rifeh* 269), while the angular high-shoulders, as 711-16, are later (*Rifeh* 383, 386). The coarse jars 728-30 are probably of the XIXth dynasty.

We now note some groups of pottery found in

tombs under the Nebunef temple, N 4, N 8. The small pot 735 was found with the alabaster kohl pot 736. The variety of form of 744-57 is puzzling. Some, as 749, 750, seem clearly of middle XVIIIth dynasty (*Rifeh* 383); also compare 751 with *Rifeh* 313, and 747-8 with *Rifeh* 166. Yet the dull pinky-brown colour and forms of 753-6 seem almost as if Ptolemaic. The same grouping is however found in another tomb where 741 was along with the cup 746. Then again 757 looks certainly like much later pottery, being an almost globular pilgrim bottle of large size, like 742, 743 (not in groups); only as the pilgrim bottle begins in the XVIIIth dynasty, it is possible that large sizes were then made. We must hesitate then where to date 741, 753-6, which seem to be foreign pottery, and for which the XVIIIth dynasty is indicated. The two red polished jars 737, 738, the latter with black top, seem also to be foreign, perhaps Nubian. The tomb B 15 in which they were found was of the XIth dynasty.

28. In the temple of Sety I at Qurneh a few of the most important parts were copied facsimile in full size. In Pl. XLIII is the figure of Rameses I in his shrine, protected by the hawk above it; this is from chamber F of Baedeker's plan. The hawk is entitled "Horus the son of Osiris protecting the king Rameses." And before the king is "The Osiris the king Men-pehti-ra *ma-kheru* Rameses *ma-kheru*." The strip of inscription is that down the jambs of the door of the chamber containing the shrine scene, recording "the son of the sun, lord of the crowns, Mery Amen Rameses, made by him for his monuments for the father of his father the good god Men-pehti-ra *ma-kheru*." This inscription was therefore set up by Rameses II.

Pl. XLIV shews the row of standards on the sides of the central chamber; parts defective on one side have been completed here from the opposite scene. These appear to be the standards of the principal centres of early Egyptian worship. The ram is Khnumu of the Ist nome, Elephantine. The next is the head of Mut of the IVth nome, Thebes. Next come the two hawks of the Vth nome, Koptos. Then the sacred head or wig of Osiris of the VIIIth nome, Abydos. Following are the jackals, Upuati of the south and of the north, of the XIIIth nome, Asyut. Then a king's head which may be that of the XXth nome, Henen-suten, or the royal youth. The sistrum may be that of Hathor of the XXIth nome, Aphroditopolis. Lastly is the mace of Memphis, the name of which city, *Andu hes*, may more

likely mean the fortification of the mace-bearing king, rather than merely the "white wall." The mace is here upheld by a support, like that shewn upholding the statues of Min.

Pl. XLV. At the top is the head of the *ka* of the temple, with the name of the "Divine House of the son of the sun Sety Merenptah in the dwelling of Amen on the west of Thebes." Beside it is a copy of the tablet of Siptah, adoring Aahmes Nefertari, Sety I, and Ramessu II, inscribed on the front wall north of the entrance. This was also at one time inscribed by Amen-messu; and it has been published by Lepsius (*Denk.* iii, 201 c) in so conventional a style that it is desirable to shew the actual appearance of it, which is very rude. There are a few differences between the readings here and those of Lepsius; in some of these the present reading is certainly right, the others must be examined in future. But as evidently the later conditions of lighting were better than those for the earlier copy, the present readings must be considered. Below is a group of offerings, to shew the forms of the various vases. The strange rectangles on stands at the right hand are very unusual.

29. While waiting for permission to extend our work to the Nebunef site I worked over a part of the store-chambers of the temple of Sety I. Most of the pottery belonged to later occupation down to the XXVIth dynasty. Below it were many sealings of coarse plaster, from which I copied sixteen different seals, given in Pl. XLVI. Seals 1 and 2 are for "Oil of the glorious temple of Sety in the house of Amen." Seal 3 is for "Wine of the glorious temple of Sety." Seal 4 for "Wine of the glorious temple of Sety in the house of Amen." Seal 5, "Wine of the (glorious) temple of Sety." Seal 6 only reads "Wine of Sety. . . ." Seal 7 is "Men-maat-ra oil of. . . ." Seal 8 reads "Palace of Maat-men-ra, excellent wine from upon the west (of Thebes)." Seal 9 is "Men-maat-ra, unguent of the palace upon the west of Thebes." Seal 10, "Men-maat-ra, honey of the palace upon the west of Thebes." Seal 11 is for "Wine of . . . of Uti." Seal 12 is remarkable, being for "Oil of the house of Bantanta," shewing that oil was still brought to this temple late in the reign of Ramessu II, after his daughter had estates. Seal 13 is for "Fresh oil of ducks" or animal oil. Seal 14 may have had a ram's head with the double feather. Seals 15, 16 are a well-known type, "Arat nefer (neb) ka," or the *ka* of the good goddess, or of Uazet. No. 17 is a stamp of the palace of Ramessu Meri-

amen. No. 18 is a fragment of the name and titles of Nebunnef from his temple.

30. As soon as Prof. Maspero agreed to my working further on the edge of the desert, I began upon a site between the temple of Amenhotep I and that of Sety I. There lay on the surface two broken colossi of black granite, with the names of Ramessu II, and some blocks of stone were visible in the ground. We began to clear the site along the east side, and advanced across to the west. The blocks found here were none of them above the floor-level of the temple; they consisted of foundations, mostly level with the floor, as shewn by the bases of two columns. The plan given in Pl. XLVII was made by laying out lines of taping at 200 inches apart, the line of zeros being square with the taped lines. Offsets were then measured to points of each stone, and drawn on squared paper one by one as they were measured.

Beginning at the south end, there are the two colossi, which are here shaded with cross-lines, the foot end of the base being separated by a line. The shading does not shew the present places of the blocks, but the positions where they last stood before they were tilted over to be broken up. They seem to have been placed upon the blocks of stone north of them, and to have been dragged forward and twisted round before they were broken up. The estimated positions of columns and walls are shewn by dotted lines. The row of columns on the western side of the peristyle court was curiously askew, and the axis from between the bases of the colossi to the temple behind is similarly askew, as well as the west boundary-wall of brick. The cause of this is not known. Another strange irregularity is having three intercolumniations on the west of the temple door, and only two on the east side. The diameters of the column bases drawn here were fixed by finding half of the base in the middle of the east side, 56 inches across.

From the row of small blocks, and the width of interval between the southern columns and the front wall of the temple, it seems as if there were two rows of columns on the north side of the court. The front wall of the temple is defined by the line of blocks, and by one at the entrance to the west chamber being a door-sill of sandstone among all the other blocks of limestone. The chambers on the east must have been wider than those on the west, as shewn both by the places of the foundations and by the places of the column bases of sandstone. The cross-wall in the middle of the temple is only suggested by

a few blocks, but in any case it is not likely that chambers would have been so long as 45 feet while only 8 or 12 feet wide.

The date of the building is only given by the foundation deposits. One deposit is marked DEP.; another was at about a symmetrical position on the east (unfortunately omitted in planning); and perhaps there was an axial one in the same line, as many scattered objects were found along this region. The arrangement of the parts of the eastern deposit which remained in place is shewn on the left side of Pl. VIII. Two small boxes of brickwork each contained two limestone tablets (N) inscribed for Nebunnef, high priest of Amen and Ramessu II. For these and other objects see Pl. XXXIII. In the south box between the limestone tablets was a green glazed one (B) of Ramessu II. In the south-east corners of the boxes were corn-grinders of limestone (L) and granite (GR). The small glazed objects had all been scattered at the upheaval of the limestone foundations. The colours of them were blue 157 objects, red 39, white 15, brown-black 13. Of the royal plaques of Ramessu II most were with the *user* on legs, or *se-user* a form rarely found, and apparently by this preceding the usual form. The total numbers of objects found are—

Cartouches, <i>Seuser-maat-ra</i>	12
<i>User-maat-ra</i>	1
<i>Ramessu</i>	9
Nebunnef, high priest of Amen	5
Ox with legs bound	32
Ox haunch	72
Ox head	45
Bunch of vegetables (?)	24
Grain of corn	24
	—
	224

There were also one each of bronze models of axe, adze, knife, borer, and lever. The limestone block in the western deposit names Nebunnef as high priest of Hathor. In his tomb at Thebes is an inscription naming the first year of Ramessu II, which shews that he was high priest at the king's accession. He seems to have built this temple as a small work of his own while directing the adjacent temple building of Sety I at Qurneh; and he was somewhat independent under the new king, as he put his own name and titles on the foundation tablets.

31. In a tomb high up on the southern side of the little valley, at the north end of Drah abul Nega,

the wall is squared for drawing figures. These squared drawings are shewn on Pl. XLVIII. The figure is $19\frac{1}{4}$ squares in height. The size of squares is 2'374 inches each for the larger figure, and 2'376 horizontally and 2'330 vertically for the smaller figure. This size does not seem to belong to any usual standard; it may be a sixth of a cubit of 20 digits of '713 inch. In another tomb near by are squares of '5864 inch, evidently fifths of a palm, shewing a digit of '733 inch, or cubit of 20'52 inches. The same size of squares occurs on a draughtsman's slab at Memphis. Another scene in the same tomb has squares of '717 inch, a very short digit.

CHAPTER VI

THE LATER PERIODS.

32. POTTERY of about the XXIIInd dynasty was found, both in the store-rooms of Sety I, and also in secondary burials in cemetery B. It is here arranged on three plates XLIX, L, LI. The bowls differ from the earlier forms in having a brim, and generally the point of the bottom deeper than the foot. They also have handles, in one case four (No 768). The lumpy drab pottery with lines around it (770-9) is only found in this period. The large jars, 780-4, are of the same greenish-grey colour; it was evidently a weak clay when wet, as shewn by the constant use of cords round it for drying. The pattern on 782 was scored on it while soft; so also was the mark on 783, which is put on opposite sides, here copied together for comparison. The other jars are all of forms well known in this age.

33. An unopened tomb of about the XXVth dynasty was found in the courtyard in which are the tombs of Amen-mes and Piaay. A thick bank of brickwork covered the floor of the court on the west, and on cutting through this it was found to cover a small square pit. The unburnt bricks were mingled with pottery cones to stiffen the mass. These cones had belonged to ten different tombs, and as those tombs are doubtless not far off around this court the names may be of use in tracing positions in the cemetery. The pit was very shallow, only just deep enough to allow of a chamber roof under the court. And it was so narrow that the outer coffins could not be taken out with lids on; there was hardly an inch to spare in removing them. The plan of the tomb will be seen on Pl. VIII, and the outer and inner coffins and furniture on Pls. LII, LIII.

On the north side was the coffin of a man, painted black and inscribed faintly, with the body bandaged with stripes around, and two diagonal bands. In the outer coffin, and upon the inner, was a mass of leaf garlands. Inside the inner coffin was a pillow under the head, and a clay figure wrapped in cloth at the right of the head; also a lotus flower upon the stomach (Pl. LIII). The woman was a chantress of Amen named Per-en-bast. Her mummy was bandaged, with some lotus flowers on it, but covered with a thin coat of pitch. Her coffin is pitched, with yellow painted designs. The eyes and eyebrows are inlaid with glass. The topmost subject is Osiris enthroned with his family, then the bust of Sokar, then the cow of Hathor and the four genii, and four seated genii with knives at the feet. Along the sides are scenes of the late mythology, the serpent spitting poison on the headless enemies, etc. At the side and head of the man's coffin were two rough black boxes; these contained respectively 200 and 203 rough brown pottery ushabtis. The numbers are marked on the plan. At the shoulder stood a Sokar-Osiris figure of pitched wood. Upon the woman's coffin were two small boxes with 185 and 183 small clay ushabtis painted blue; also a Sokar-Osiris figure. The ushabtis were all packed in clean sand. Such filling might be thought to be accidental in some cases, but here it was in boxes placed bare upon the top of a coffin in a clear chamber. The boxes, ushabtis, and figures are shewn in Pl. LIII.

34. The inscription of Haa-ab-ra on Pl. LVI is cut on a quarried face at the south end of all the valley quarries, nearest to the Kings' valley. Further up the first quarry valley, on a pillar in a cave are sketches of Ta-urt twice over, and two hunting dogs. Also in one quarry that was worked in Roman times there are two Latin inscriptions, one congratulating T. Domitius Crispus (Pl. VIII), the other a long one of which only the name Demetrius is clear. The mode of quarrying in this Roman work differed from the old Egyptian in marking off intervals with a red line, probably showing the extent of each day's work. Thus the amounts done could be compared. These red lines clearly follow the course of work, and a slight shift of the face is visible at each. There are 13 in 112 inches on the roof, and 9 in 70 inches down the side. This shews over $8\frac{1}{2}$ inches a day in horizontal work, and under 8 inches in vertical. How many men were engaged along the grooves is not visible, but there must have been about four feet length to each man. As the grooves elsewhere are 18 inches wide, to allow of the worker's

body passing, there must have been about four cubic feet of stone chipped out daily by each worker. Near by is a block not yet removed. The groove round it is from 17 to 20 inches wide, and the block is 100 by 55 inches, and about 70 high. This shews that in cutting large blocks the need of the workman passing around them obliged about as much rock to be chipped out as the volume of the block which was obtained.

35. The latest class of pottery found is that of the XXVIth dynasty (Pls. LIV, LV). The forms are mostly well known of this period and perhaps rather later. The jars 833-4 and those on Pl. LV are exactly what belong to the VIIth century B.C. at Defenneh. The forms of the jars 849-57 shew them to be Greek in origin. Moreover, there are Greek monograms cut after baking, and therefore shewing the owner's marks, see next to 850. These prove the jars to have been used by Greeks. From the quantity of Greek jars, and the marks, it appears that there was a colony of Greeks at Thebes in the VIIth century. Probably this was a small Greek garrison, like the frontier garrisons, planted by Psamtek.

In a site so long occupied as Thebes the excavator has to take what comes, and should preserve the record of the remains of all periods that may be found. The present two months' work has, however, cleared up the XIth dynasty cemetery and pottery, and the contemporaneous chapel of Sankhka-ra; while the search for tombs in the valleys has produced the most complete burial of the XVIIth dynasty, one of the best funeral series found at Thebes. The various other discoveries are welcome additions to the main matters of research, which have fully repaid the short time spent upon them while waiting to resume the great work at Memphis.

CHAPTER VII

THE INSCRIPTIONS.

By Dr. J. H. WALKER.

36. PL. III. These two steles of the XIth dynasty form an interesting addition to the very small number of steles, which have been preserved, of this period. The hieroglyphs are coarse and rudely cut, as they are on the stele of Antef V (*Koptos*, Pl. VIII), and on the contemporary steles of Denderch (*Dend.* XI C, XII). The hieroglyph for the letter *f* has the head separated from the body, and at the end of line 2 of the second stele, in the

King's name Antef only the head of the hieroglyph appears, the body is omitted altogether. Unfortunately no clear historical reference is given, whereby the position of the King *Hor-uah-ankh* can be definitely fixed in the dynasty. In line 4 of the second stele, the snake and feather sign of Aphroditopolis, the 10th nome of Upper Egypt, establishes this as the Northern boundary of the Kingdom of this dynasty, the "Door of the North." It clears up the badly drawn hieroglyph, determining the Northern boundary in line 3 of the stele of *Hor-uah-ankh* in Cairo Museum (*Mon. Div.* pl. 49, and *Transactions S.B.A.* iv. p. 194, also Breasted, *Ancient Records*, I. p. 200, note *a*).

The scribe has evidently confused the writing of the towns Abydos and Elephantine. In line 4 the Southern limit of the "whole Southern country" must be Elephantine, but it is written *Abu* with the city determinative, instead of the desert determinative, whilst Abydos in line 1 is written *Ab* instead of *Abdu*.

The very common formula at the beginning of both steles, which has been translated in so many different ways—the phrase *stn dj htp*—I prefer to read, "May the King give an offering table" to the deity or deities mentioned. A distinction is drawn between the *hetep* given to a god, and the *per-kheru* funeral feasts given to mortals. I consider therefore that the phrase means "May the King give an offering" to the god, in order that the god may distribute from it funeral feasts to the deceased. When in some cases no god is mentioned, but the name of the deceased follows immediately after the formula, here apparently the deceased is regarded as a god, the Osirian one, and therefore the *hetep* can fitly be given to him directly.

An interesting variation occurs at the end of line 1 and beginning of line 2 in the first stele. In the majority of the inscriptions, where the individual items of the funeral feasts are specified, the meat portions are represented by the head of an ox and the head of a bird. Here there are the heads of three different animals, as well as the bird. The same three animals are represented on a stele of funeral offerings, in *Koptos*, Pl. XI, 4.

37. *Stele No. 1.* "May the King give an offering table to Anubis upon his hill, he who is in his mummy wrappings the lord of *Ta-zeser* (the underworld), for funeral feasts to him (*i.e.* the deceased), consisting of thousands of cups of wine, oxen, wild fowl, gazelles (?), oryxes (?), linen bandages (*šs mnht*), and all good things. The prince, the confidential

friend, the superintendent of the granaries (??), the governor of the Residence, Zari, says, I was known by my lord, a great one of the palace, a man of years (*s n rnp*??), healthy of heart. I established those who knew me not, as well as those who knew me. I did that which the great ones loved, and that which was praised by the humble people, in order that Horus might extend my life upon earth (a play on the royal *Ka* name). In the next world I went forth from my house, and entered into my tomb."

In front of Zari's wife, the inscription reads, "The sole royal favourite, priestess of Hathor, Sentmentui." In front of the leg of the chair, the first hieroglyph, the wave-line 'n', may be for the negative, and thus the inscription may read, "May there never be a going away of anything from them." The wish apparently refers to the offerings on the table, that they may be perpetual.

Stele No. 2. "May the King give an offering table to Osiris, lord of Busiris, the chief of those who are in the West, lord of Abydos. The prince, the sole confidential friend, the governor of the Residence, the superintendent of the granaries (??), Zari, says, The Horus *Uah-ankh*, the King of Upper and Lower Egypt, the son of Ra, Antef, the creator of beauties, sent me a message, after I had fought with the house of Khety (?) in the domain of Thinis, and messages came that the prince had given me a boat, in order that there might be protection for the land of those who belong to the South, to its whole extent, Southwards (?) from Elephantine and Northwards to Aphroditopolis, because he knew my excellence. I say, I was promoted amongst the elders, I was fierce (?) of heart on the day of smiting." The end of the line seems to be confused; apparently the scribe had to condense his statement, for want of space. It may read: "For greatness came upon me, because I did excellent things, I was head of my nome, a mighty man, a prince."

The vertical line on the left gives the parentage of Zari, "born of the scribe (?) . . . superintendent (?) of the valley, Hesi, the prince and sole confidential friend."

In front of Zari. "The governor of the Residence, the superintendent of the granaries (?), Zari, the excellent one, deceased. I was one who was beloved of his city, and praised by his god."

It is highly probable that Khety is the right reading for the name in line 3, and thus refers to one of the very powerful princes of Siut, who fought for the Herakleopolitan rulers of the IXth and Xth

dynasties, against the rival Theban kingdom of the XIth dynasty.

38. Pl. X. Stele from tomb B 33. "May the King give an offering table, and may Anubis give an offering table, for funeral feasts to the sole confidential friend, the superintendent of the priests of Dehuti (?) . . . beloved of mankind, at the head of his fellows. I was one who provided [a gang] of twenty individuals. I was the sealer (?) of the great fields, besides the portions of my father's property. I made provisions (?) for the temple of Amen in years of scarcity. I was the sealer (?) of the sacrificial oxen (*rhs*), paying attention, at each festival of the opening of a season, to the altar tables, as far as the opening of the year festival. I acted as herdsman in charge of the asses, and as herdsman in charge of the goats, and as herdsman in charge of . . ."

It is difficult to see what the ordinal number "the 7th" (*sfl nw*) refers to, in the last line. "The 7th superintendent in the temple (*r; pr*) of Amen" seems to be quite an impossible idea.

Stele from tomb B 45, with seated figures, below.
1. "The provider (?) (*grgw*?) of the Treasury, Herhathor, deceased." 2. "The provider (?) of the Treasury, Nenni, deceased." 3. "[The lady of] the house, Ihet abu." 4. ". . . the provider (?) of the Treasury, Neferhetep, who feeds the inhabitants of his deserts on earth every day."

39. Seated figure of black granite. Pl. XXXII. "May the King give an offering table to Tum, lord of Heliopolis, and to the cycle of the gods in Asheru, in order that they may give glory, and strength, and happiness, to the *Ka* of the unique one, the excellent one, the good one who has earned the reward of merit in Thebes, the scribe of accounts in the Southern city, the scribe Usi, deceased, born of the superintendent of the granary Siamen (his father's name), born of Ked-nefer-hemt-mut (his mother's name)."

"May the King give an offering table to Amen-Ra, King of the Gods, and to Mut, lady of Asheru, in order that they may grant the receiving of *snucakes*, which come forth into the presence, and milk which comes forth upon the altar table, and breezes of the North wind, as daily rations for each day, to the *Ka* of the proclaimer of truth (*gr m;*'), the man of excellent merit, the good and excellent witness, the man of good character (*nb qd*), the possessor of singleness of speech (*nb r; w'*) who deals not in double-tongued speech (*tm ir nswi*), the scribe of accounts Usi."

INDEX

- Aahmes Nefertari, 12, 13
 cattle of, 11
- Alabaster vases, XIth dynasty, 3
 XVIIth dynasty, 8
- Amenhotep I on stele, 12
- Amenhotep, son of Hapu, sarcophagus, 12
- Amen-mes, tomb of, 11, 12
- Amen-messu, tablet of, 13
- Antef cemetery, 2
 steles, 3, 16, 17
- Antef, Ra-seshes-up-maat, stele, 12
- Antef-mes, seated figure of, 12
- Aphroditopolis frontier of Antefs, 3, 16, 17
- Armlets of gold, 9
- Auab, 11
-
- Baka tomb, 11
- Bangles of gold, 9
 of silver, 12
- Bantanta, house of, 13
- Baskets of XVIIth dynasty, 7, 8
- Bead pouch, 8
- Beads loose on mummy, 8
 of XIth dynasty, 3
- Bed-frames, 6
- Bird vase, 3
- Black pottery, 12
- Box of XVIIth dynasty, 7
 of infant burial, 10
- Button of electrum, 9
-
- Calf weight, 11
- Cenotaph of Sankh-ka-ra, 5
- Chair of XVIIth dynasty, 7
- Cloth on mummy, 8
 gauge of, 8
- Coffin of XVIIth dynasty, 7
 of pottery, 12
-
- Collar of gold, 9
- Colossi of Ramessu II, 14
- Cones of pottery, 10, 12
- Corn-grinders in deposit, 14
- Couch and figure, 12
- Crispus, T. Domitius, 15
- Cubit of Sankh-ka-ra, 6
 of XVIIth dynasty, 7
 of squared walls, 15
- Cutter of bronze, 7, 8, 12
-
- Dancers, fresco of, 11
- Dates with burial, 7
- Demetrius, inscription of, 15
- Digit, 7, 15
- Drawing, squares for, 15
- Ducks, catching and cleaning, 11
 oil of, 13
- Dūm* nuts, 7
-
- Ear-rings of gold, 9
- Electrum girdle, 9
 button, 9
-
- Farshut road, 1
- Fat buried, 7
- Female figure on couch, 12
- Flint flakes of XVIIth dynasty, 7
- Fly whisk of beads, 8
- Forts, 2
- Fresco of dancers, 11
-
- Geometric style of VIth dynasty, 4
- Girdle of electrum, 9
- Girl playing double pipes, 11
- Glass, blue, 12

- Glazed tablets in deposit, 14
 Gold bangles, 9
 collar, 9
 ear-rings, 9
 ring-beads, 10
 Goose, figure of, 11
 Grapes with burial, 7
 Greek settlement at Qurneh, 16
- Haa-ab-ra, inscription of, 15
 Haematite kohl stick, 12
 Head-rest, 8
 Her-hathor, 17
 Hippopotamus weight, 11
 Honey, sealing of, 13
 Horn, decorated, 7
 Huy, scribe, 12
- Ihet-abu, 17
 Intact burial of XVIIth dynasty, 6-10
- Jewellery on mummy, 9
- Ka* of temple figured, 13
 Ked-nefer-hemt-mut, 17
 Khauy, cones of, 12
 Khety of Thinis, 17
 Kohl pots of XIth dynasty, 3
 XVIIth dynasty, 8, 10
 XVIIIth dynasty, 12
- Latin inscriptions, 15
 Limestone, black kohl pot, 12
- Mace standard, 13
 Mackay, Mr. E., 2
 Marble, blue, bowl, 7
 Memphis, name of, 13
 Mentuhotep, Osiris figure of, 6
 Mery, 11
 Mes, wife of Baka, 11
 Mes-tesher, figure of, 12
 Monkey bowl, 7
 Mummy of XVIIth dynasty, 7
 wrappings of, 8, 10
- Nebunnef foundation deposits, 14
 temple of, 14
 burials under temple, 12, 13
 Needles, 12
 Neferhetep, 17
 Nenni, 17
 Nets around pottery, 6, 7
- Obsidian kohl pot, 8
 Oil, sealings of, 13
 Osirification of the king, 6
- Palaeolithic seats, 1
 Perenbast, coffin of, 15
 Petrie, Mrs., 2, 11
 Piaay, tomb of, 11
 Pipes, musical, 11
 Pit tombs, 2, 3
 Plan of valleys, 1, 4
 Portico tombs, 3
 Pottery, dating of, 2, 4
 XIth—XIIth dynasty, 2, 3, 4
 XVIIIth dynasty, 12, 13
 XXIInd dynasty, 15
 XXVIth dynasty, 16
 in nets, 6, 7
 shewn in tomb scene, 11
- Pyrites, 12
- Quarry cutting, 15
 Qurneh, position of site, 1
- Rameses I, figure of, 13
 Ramessu II, deposit of, 14
- Sankh-ka-ra cenotaph, 5
 chapel, 5
 inscriptions, 5
- Scarab on mummy, 9
 Sealings of Sety I, 13
 Se-ankh-nu, 11
Sed feast, 5, 6
 Sen-mut, cone of, 10
 Sent-mentui on stele, 17
 Sentry walks, 1
 Serpentine, black, kohl pot, 12

- Serpentine, brown, vase of, 12
 Setu, base of, 12
 Sety I, store chambers of, 13
 temple sculptures, 13
 Sharpening stones, 3, 7
 Shrine carried in procession, 11
 Silver bangles, 12
 Siptah, tablet of, 13
 Sit-hathor, 11
 Siut, princes of, 17
 Skull of XVIIth dynasty, 10
 Skulls of XIth dynasty, 2
 Soul-houses, modern, 4
 Squared wall for drawing, 15
 Standards of religious centres, 13
 Stele set in pyramid, 11
 Stick buried with pots, 6
Stn d) htp formula, 16
 Stone, rate of cutting, 15
 Stools of XVIIth dynasty, 7
Suten di hotep formula, 16

 Taro, seated, 11
 Taurt, sketch of, 15
 Thinis attacked, 17
 Threading of seat, 7
 Tombs, direction of 2

 Tombs, pit and portico, 2, 3
 Tools, models of, 14

 Uazet, sealing of, 13
 Uazy, 11
 Unguent, sealing of, 13
 Ushabtis in boxes, 15
 number of, 15
 Usi, granite figure of, 12, 17
 sister of Setu, 12

 Valleys, plan of, 1, 4

 Wainwright, Mr., 2
 Walker, Dr. J. H., chapter by, 16
 Weighing, scenes of, 11
 Weight of eighty grains, 9
 Weights, forms of, 11
 Wildfowl, painting of, 11
 Wine sealings, 13
 store, 11
 Wrappings of mummy, 8, 9, 10

 Zara, steles of, 3, 16, 17



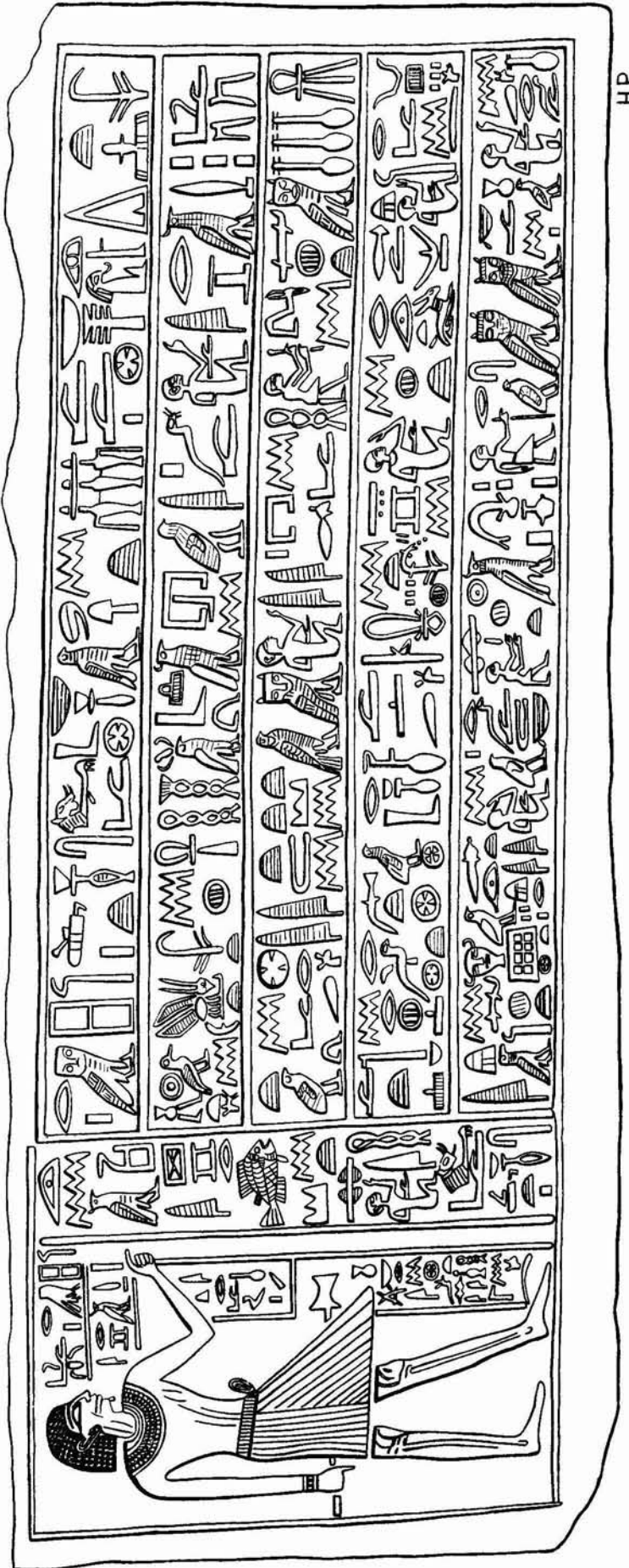
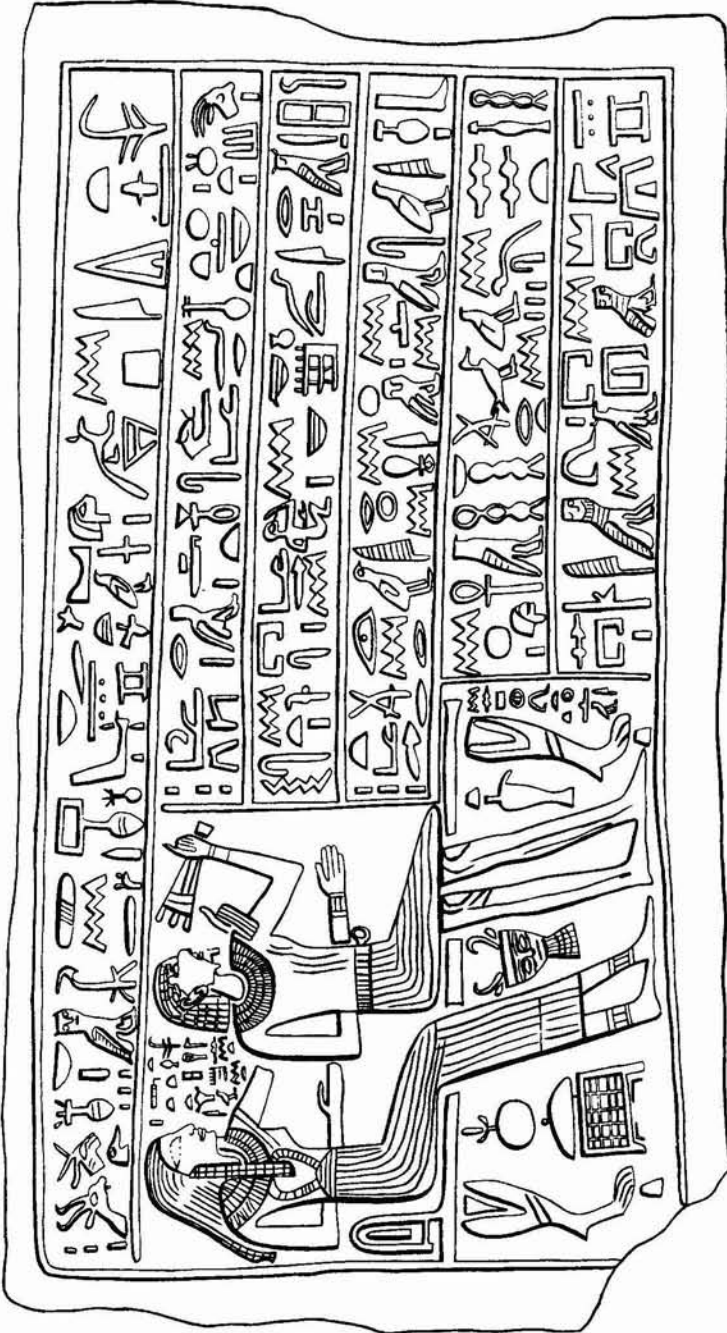

H.P.

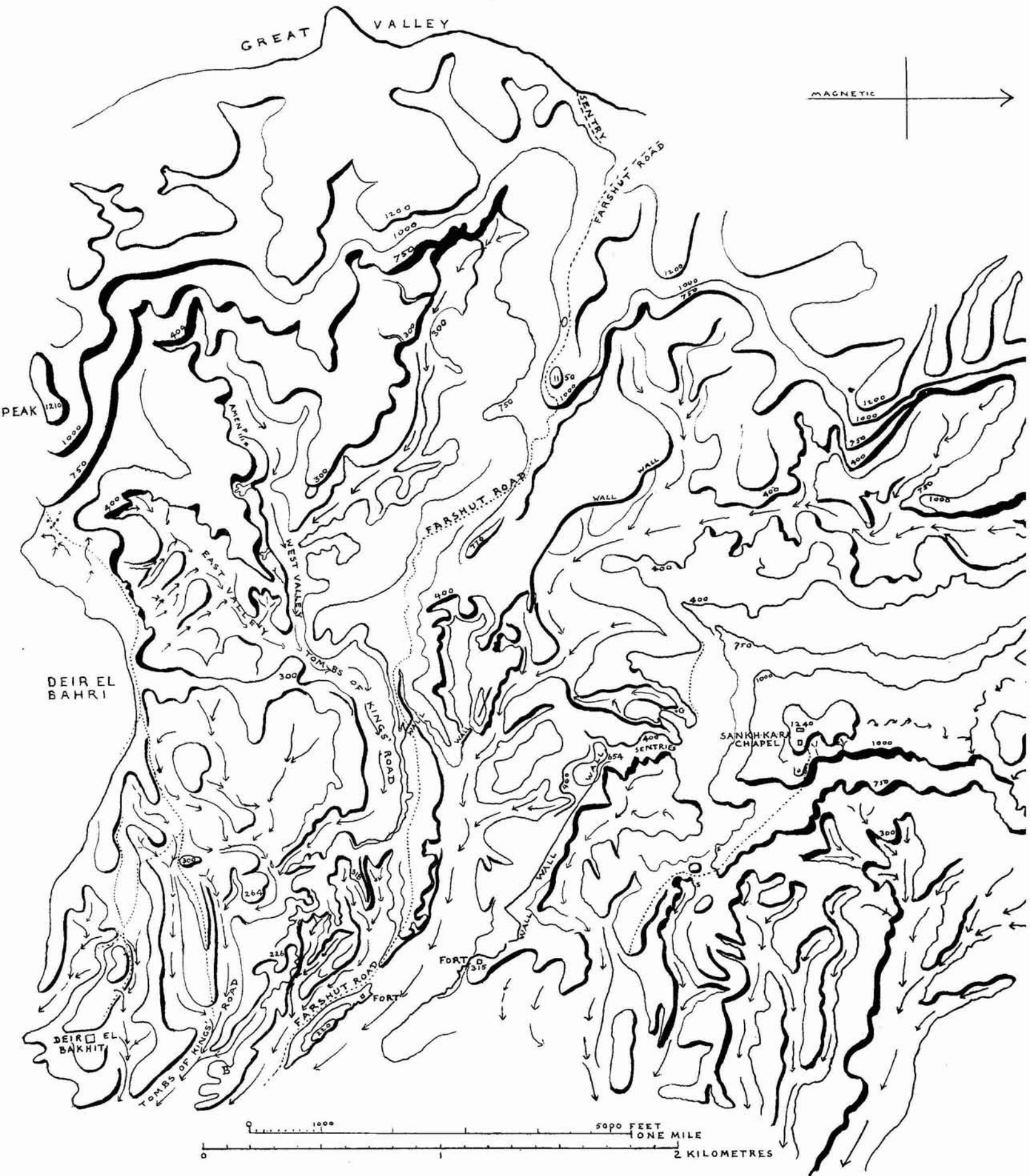



VIEW OF HILL, FROM THE SOUTH.



OUTSIDE OF CHAPEL.



SHRINE OF CHAPEL.

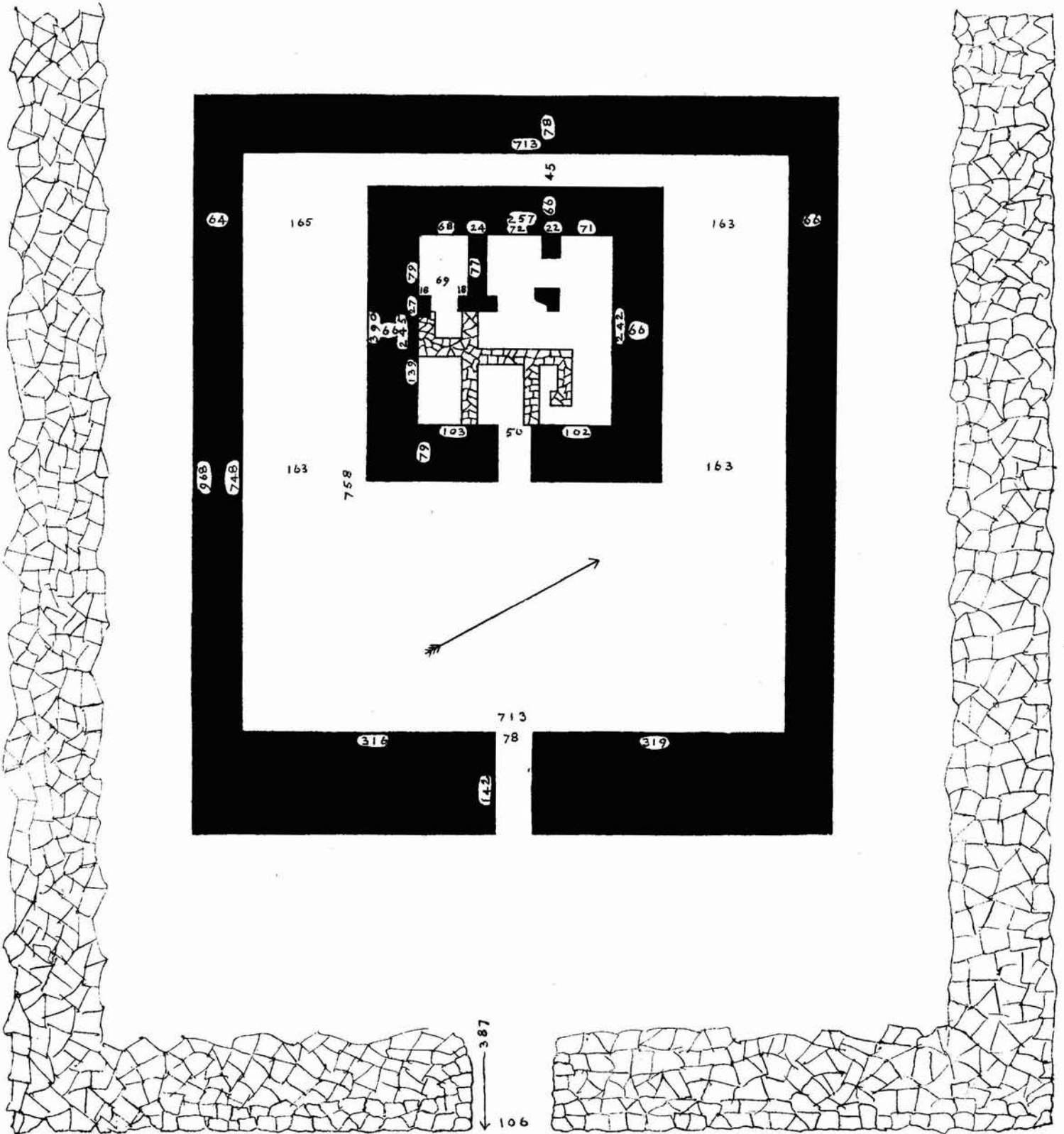

E.M.

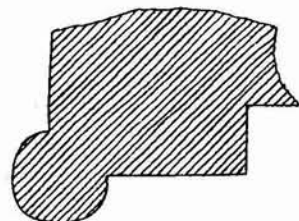
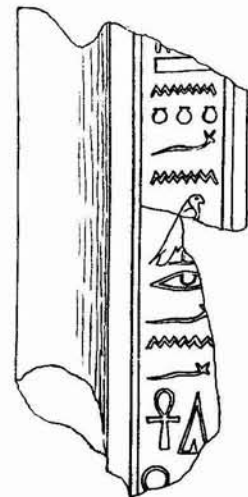
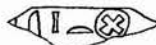
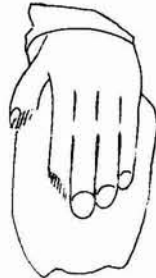
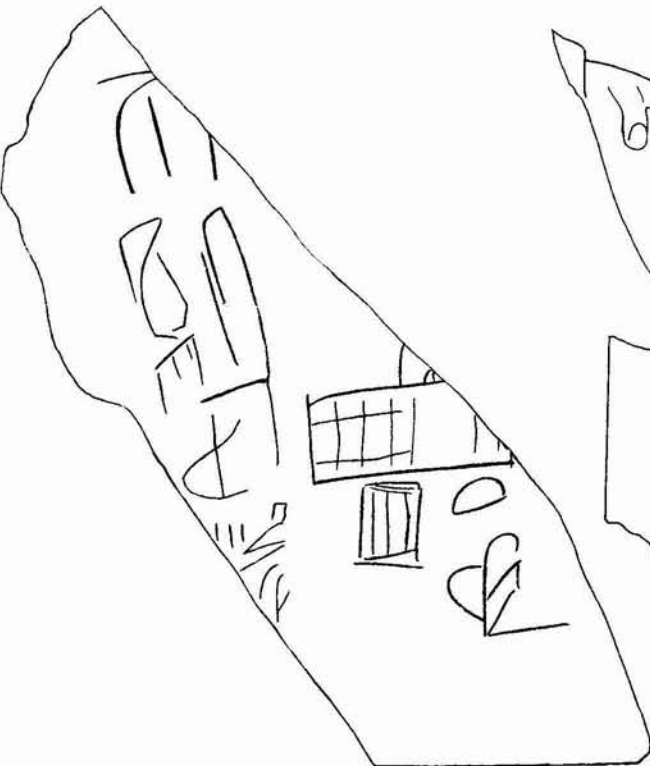
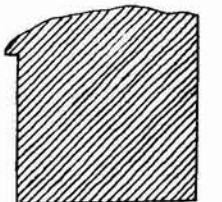
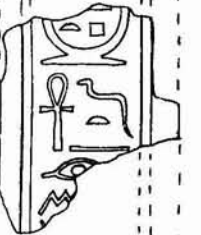
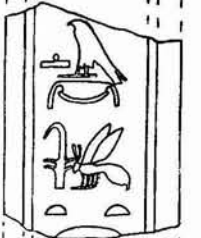
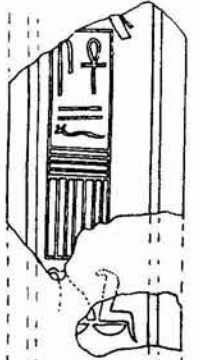
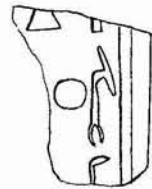
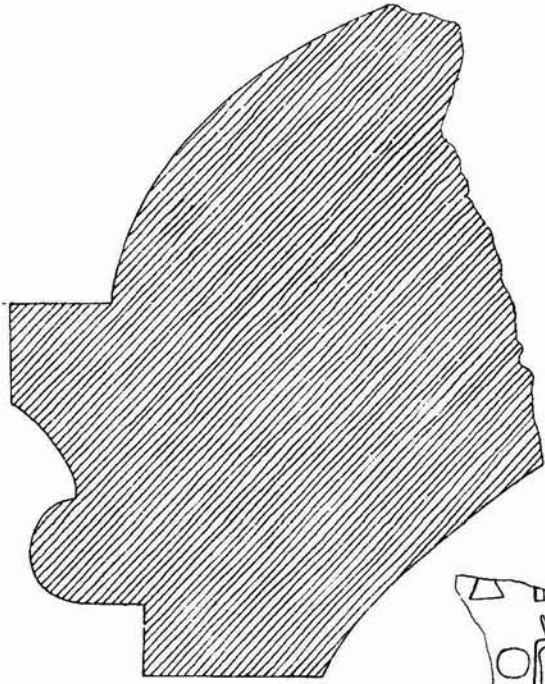
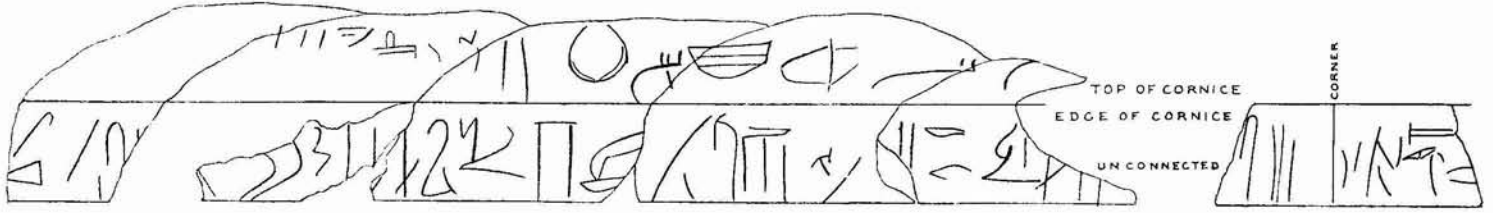

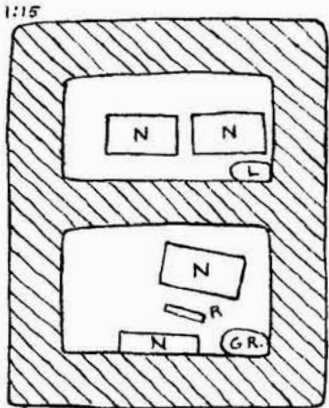
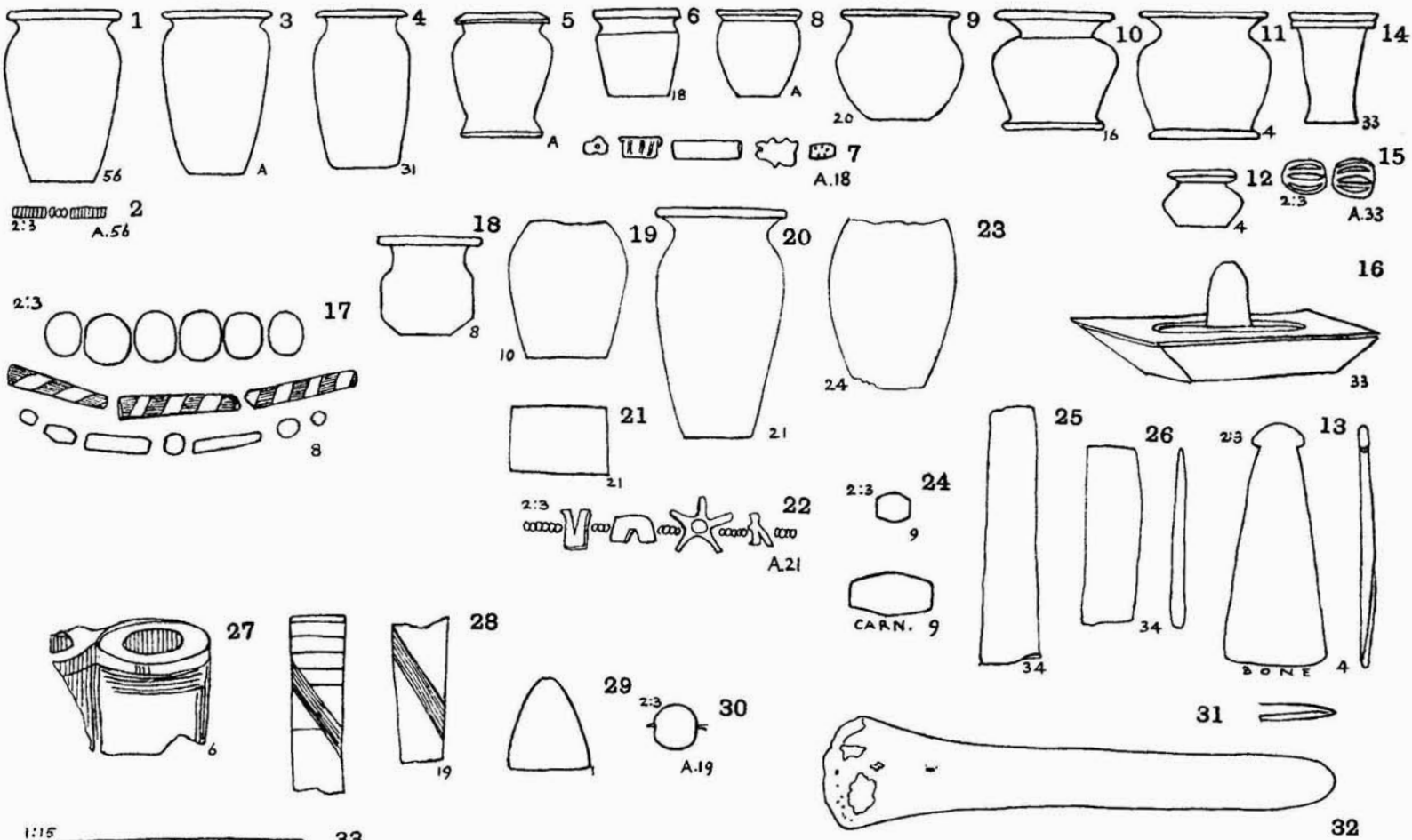

FOUNDATION DEPOSIT OF NEBUNNEF.

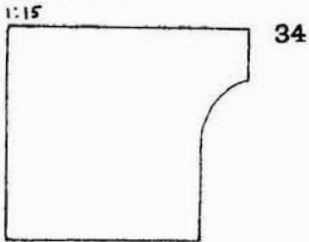

CAVETTO BRICK OF PYRAMID CORNICE

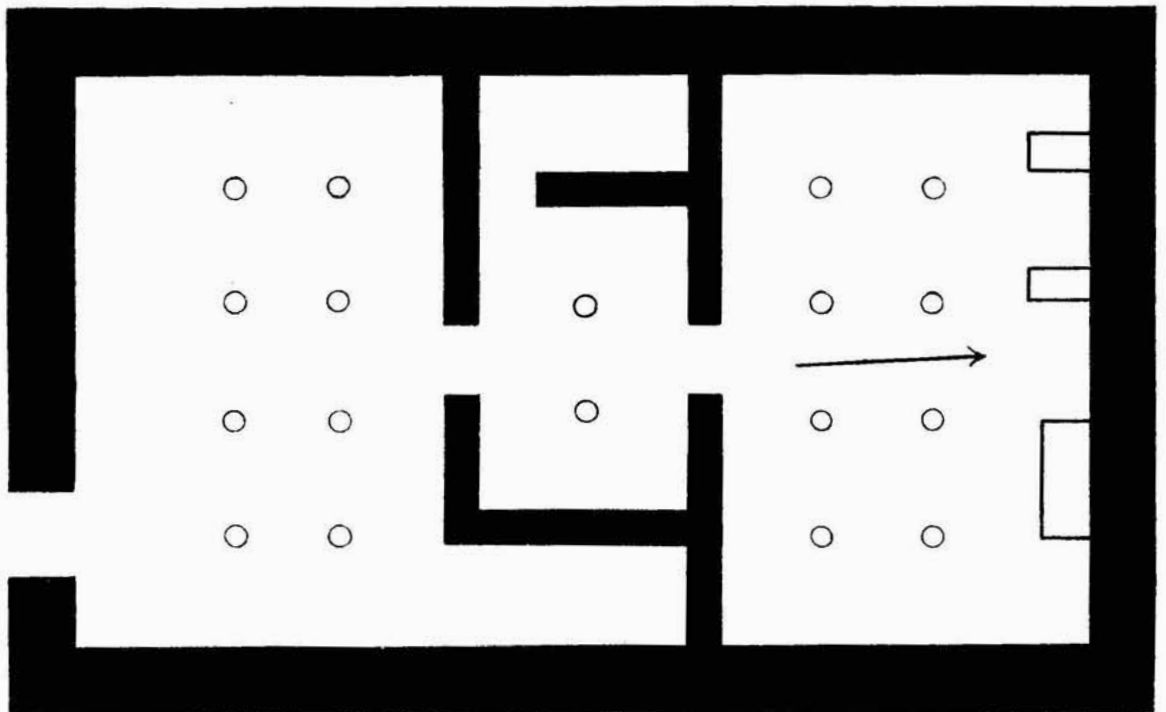

ROOMS BEHIND CHAPEL OF SANKH-KA-R A.

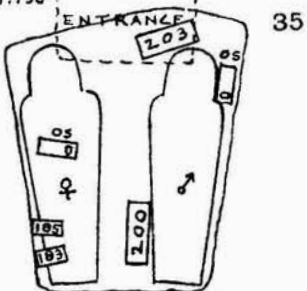

TOMB OF XXV DYNASTY.

36
 ΔΕΜΕΤΡΙΟΥΣ
 38
 ΕΥΤΥΧΗ
 39
 Τ. ΔΟΜΙΤΙΟΥ ΚΡΙΣΤΟΥ ΦΕΛΙΧΙΤΑΤΕΡ
 37
 ΕΥΤΥΧΗ ΛΥΟΙ

QUARRY GRAFFITI

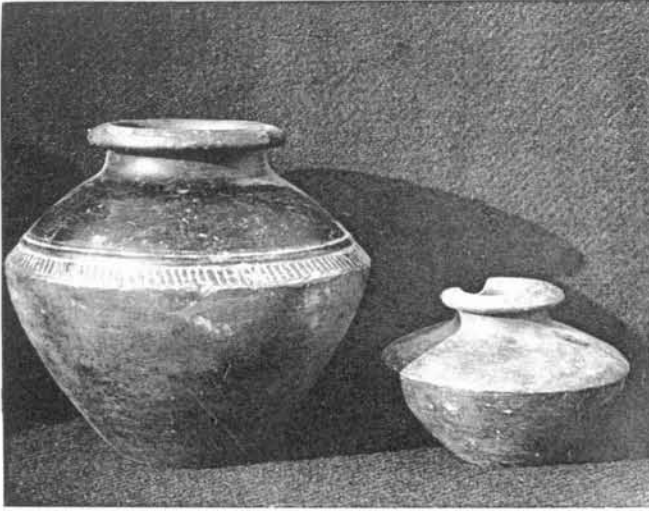

BLACK TOPPED RED POTTERY.

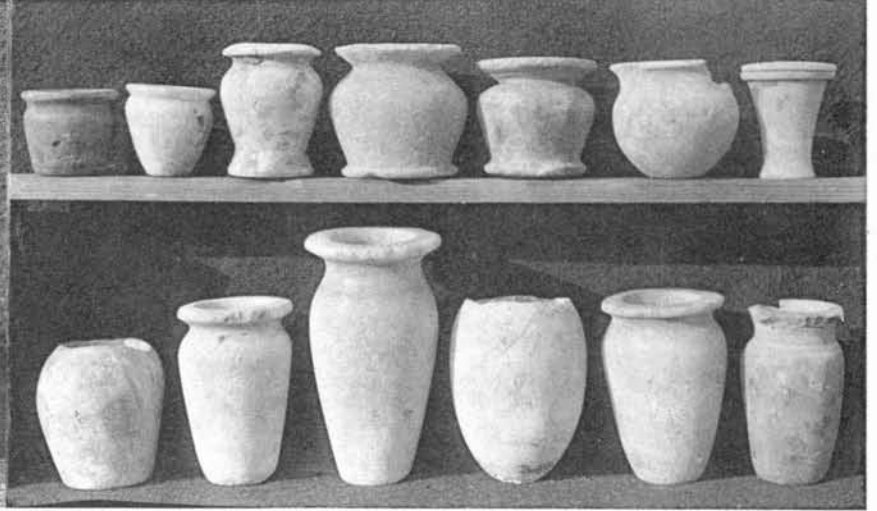

ALABASTER KOHL VASES.

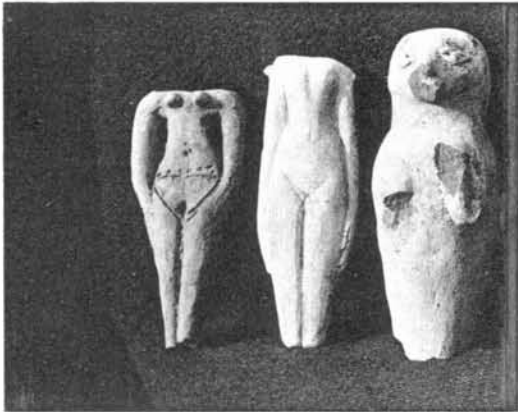

B.19. B.30. B.

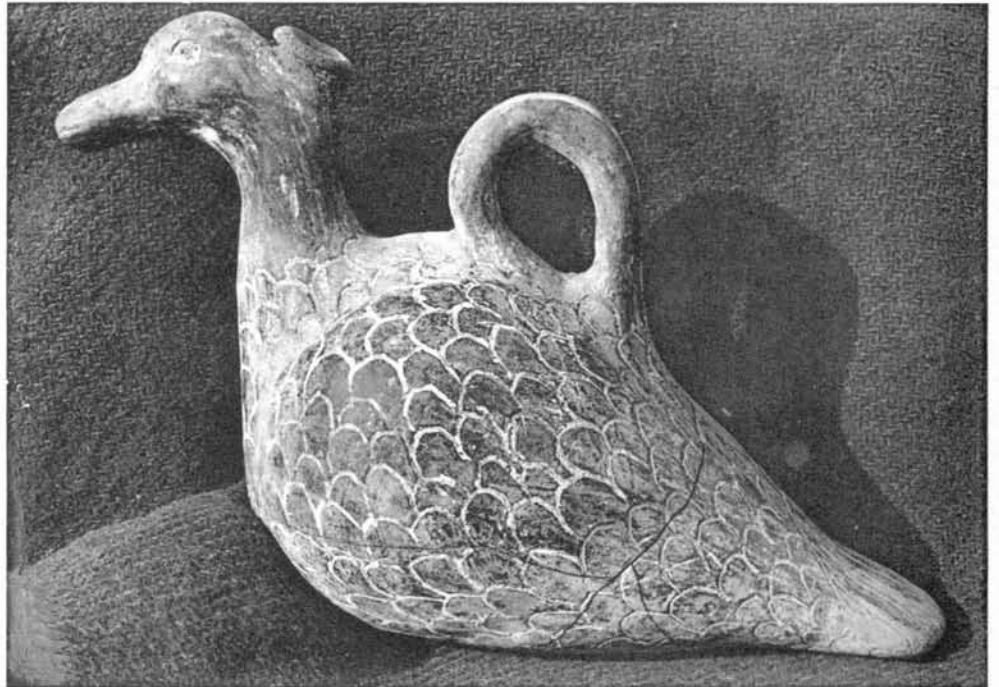

BLACK POTTERY BIRD. B.23.

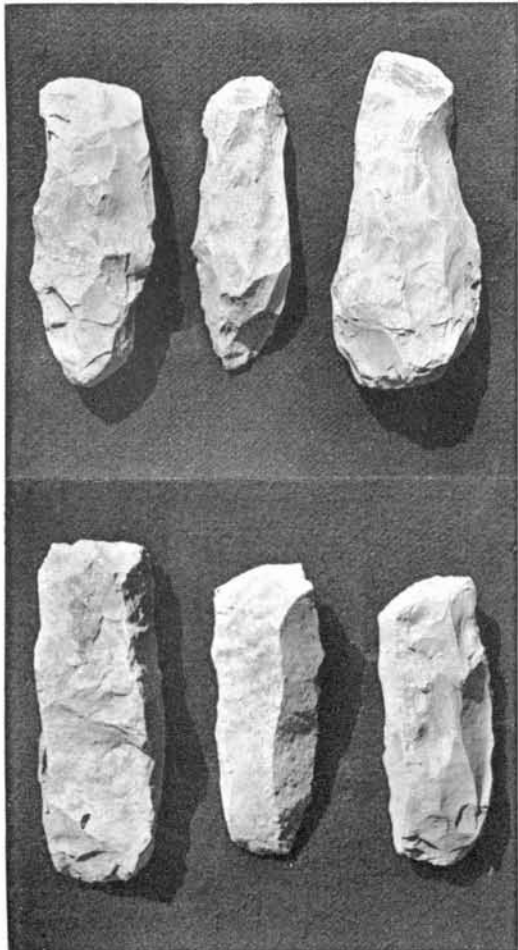

MAULS OF XVIII. DYNASTY.

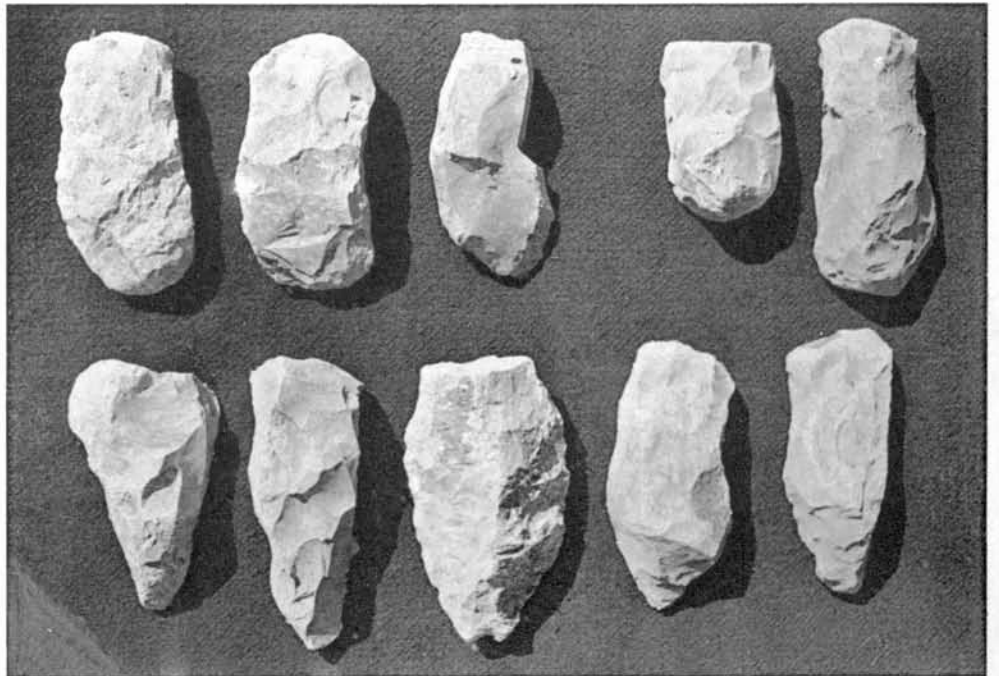

MAULS OF XII DYNASTY.



B.33

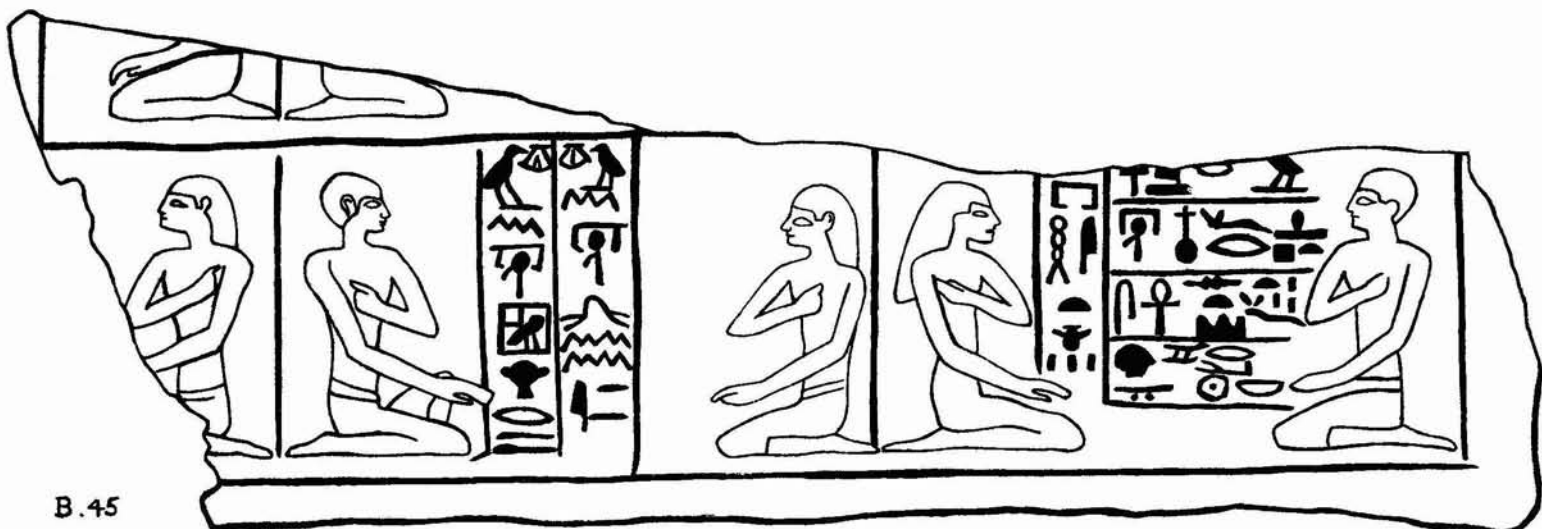

B.45

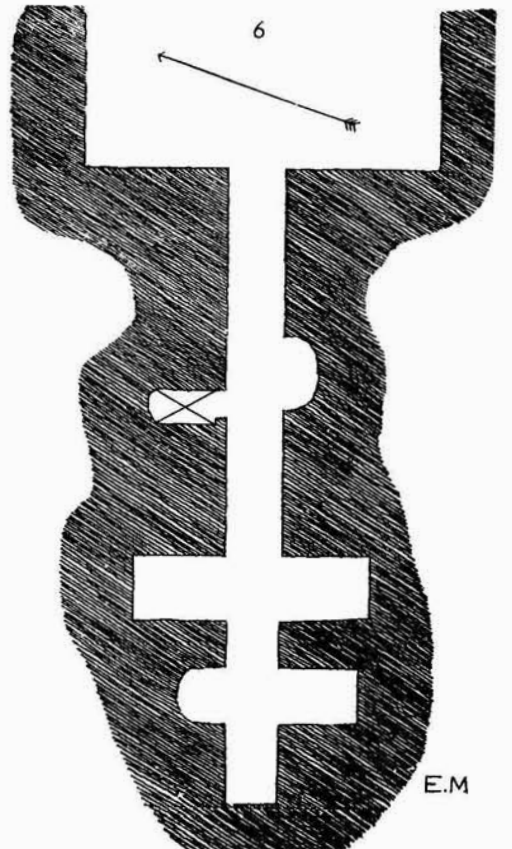
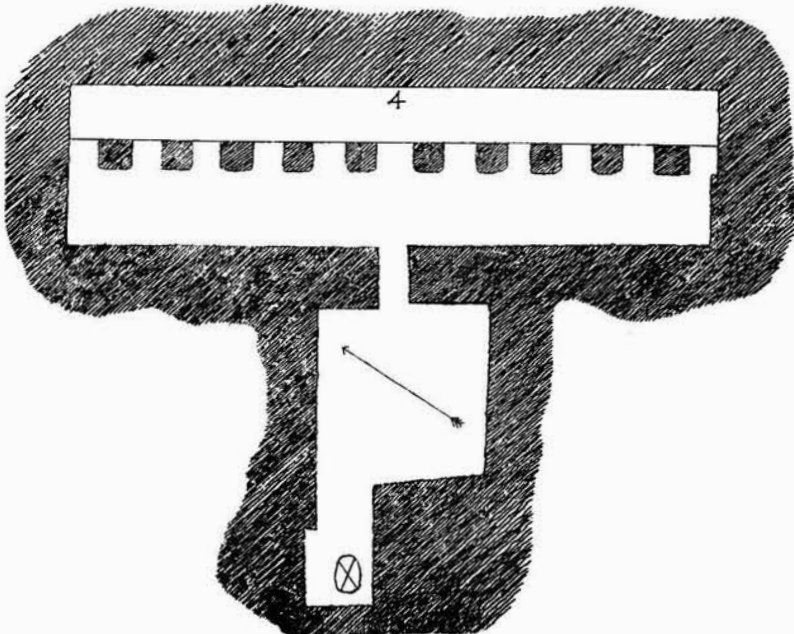
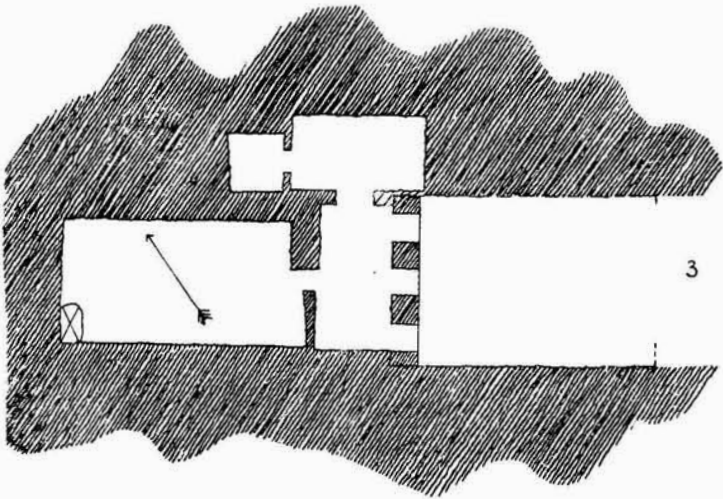
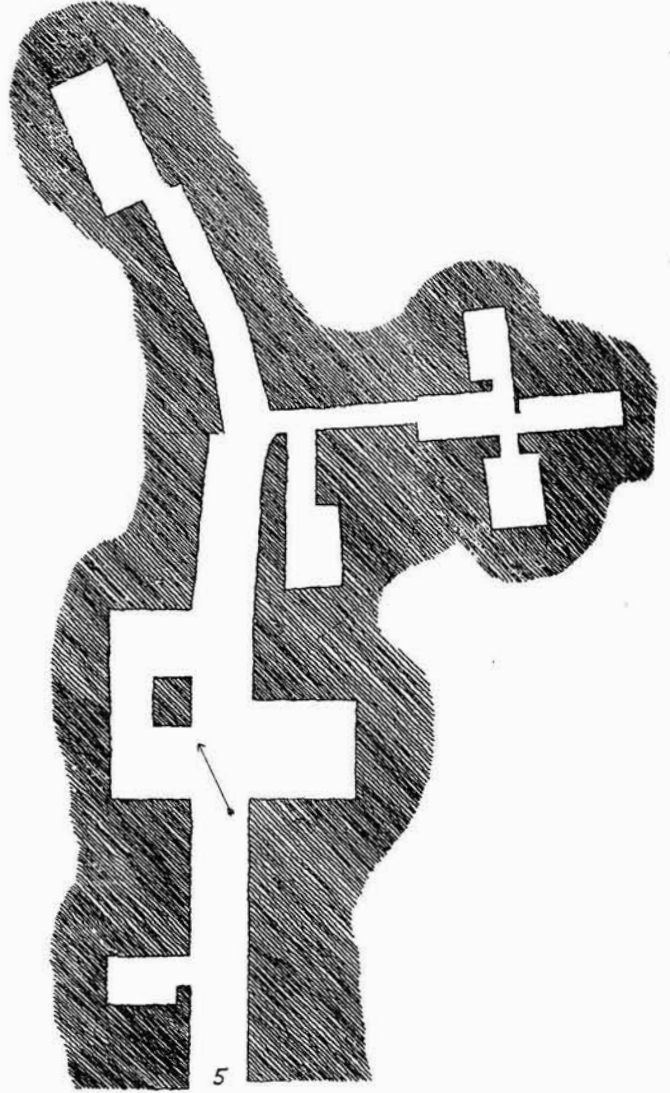
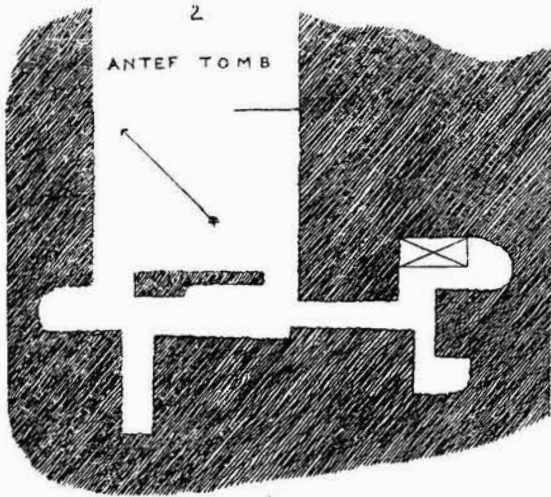
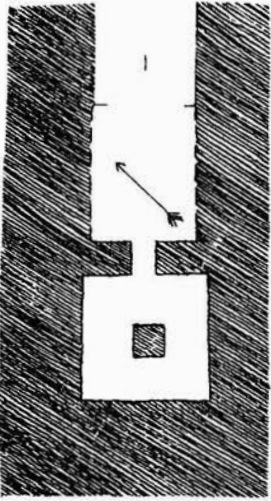



18

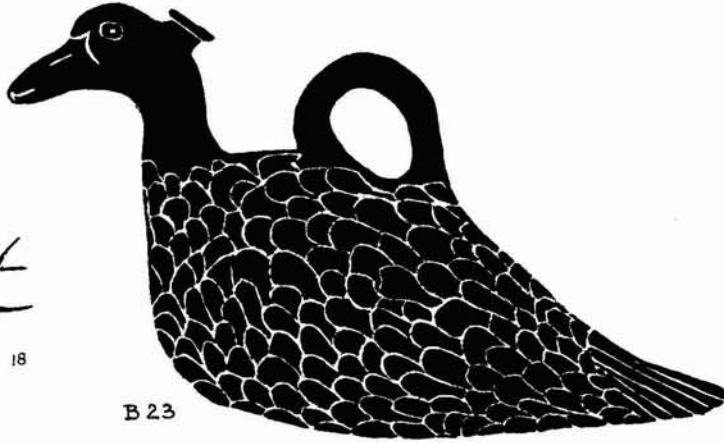

B.23

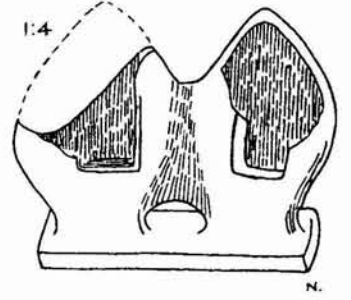

1:4

N.



A.4

CARN. BONE SHELL



B.20



A.14

AGATE GARN. HAEM. CARN. AGATE



B.23

SARD. CARN.

A.5



A.15



B.25



B.19



B.19



A.46



A.46



Z.



N.



H.P.

N.

F.P.

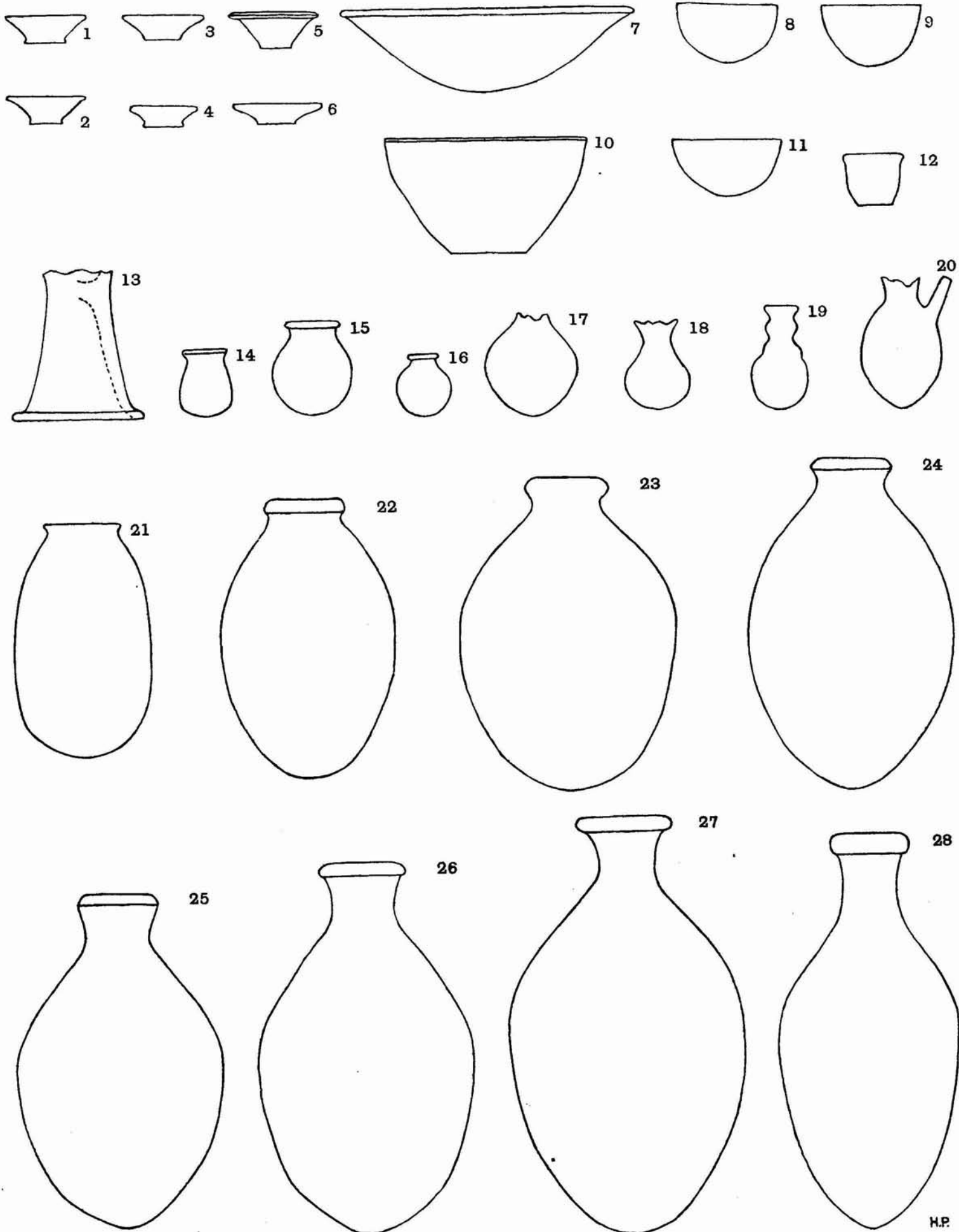

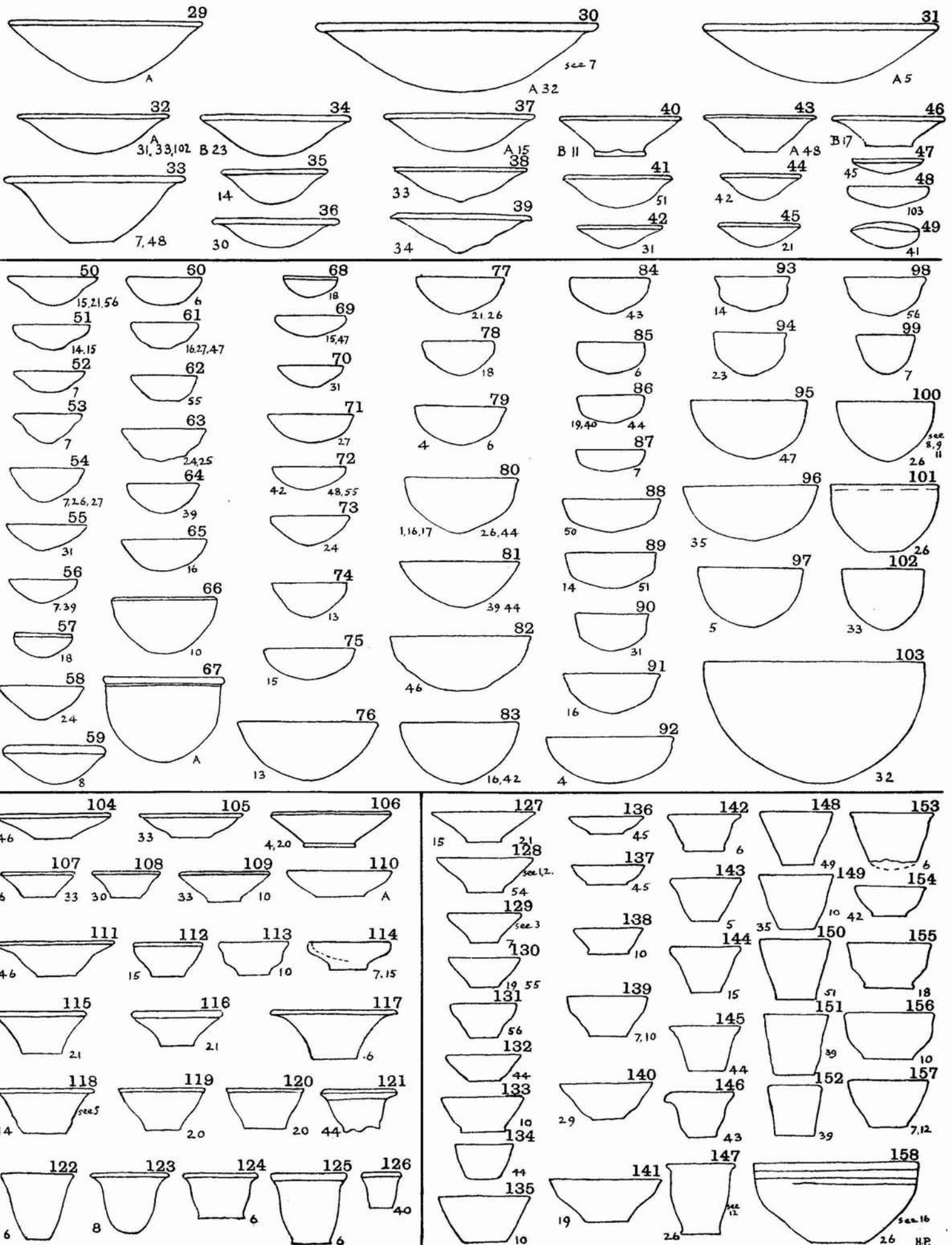

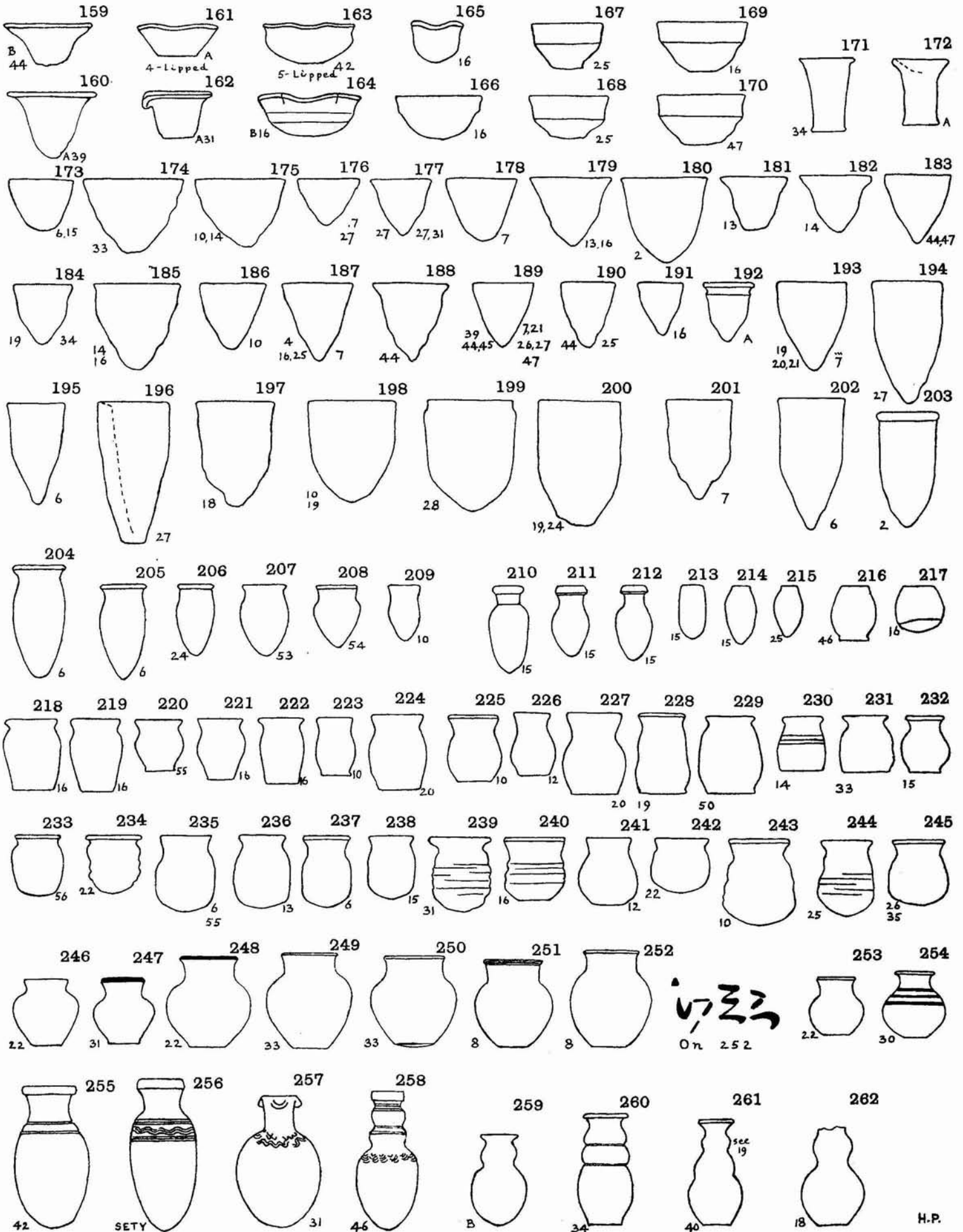

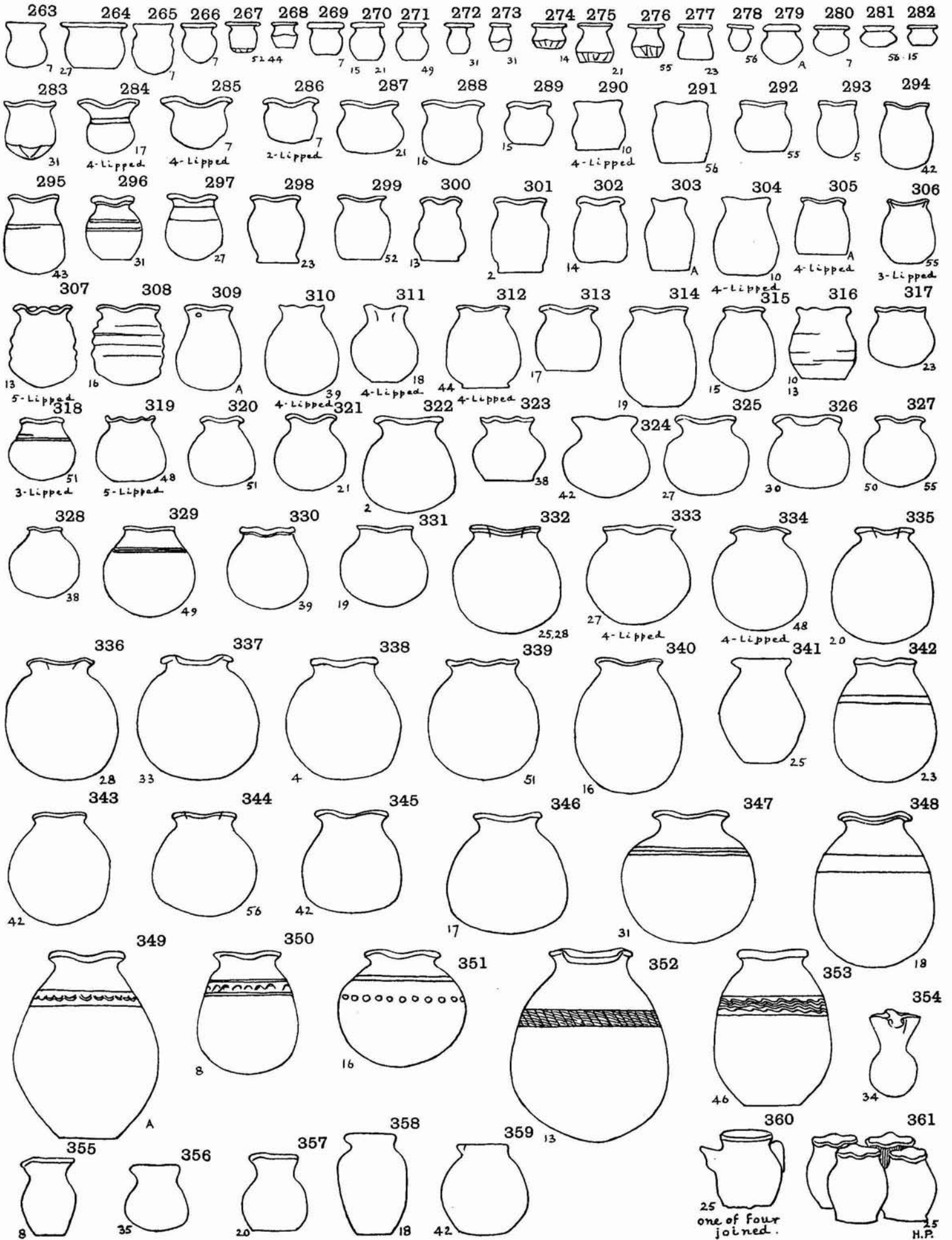

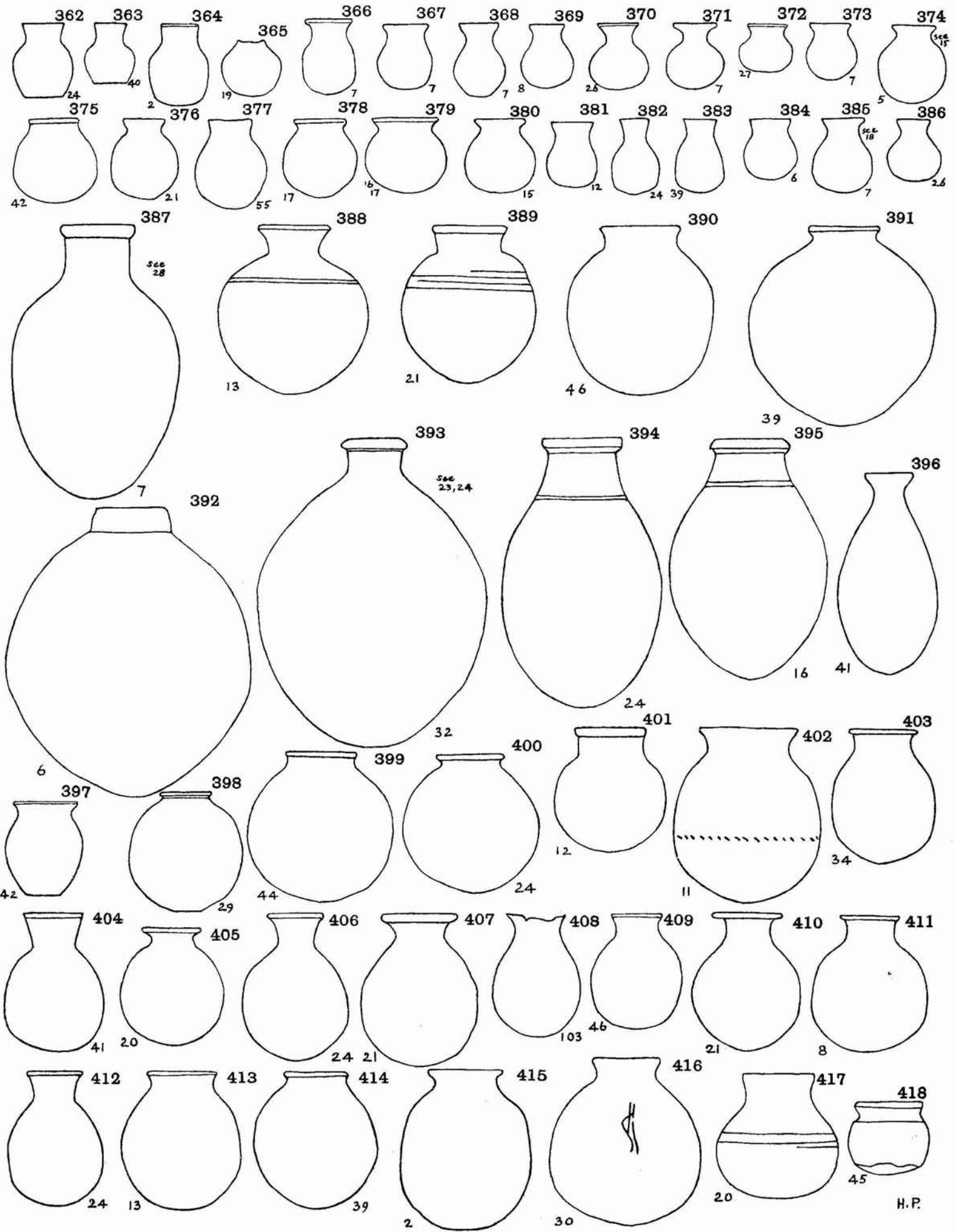

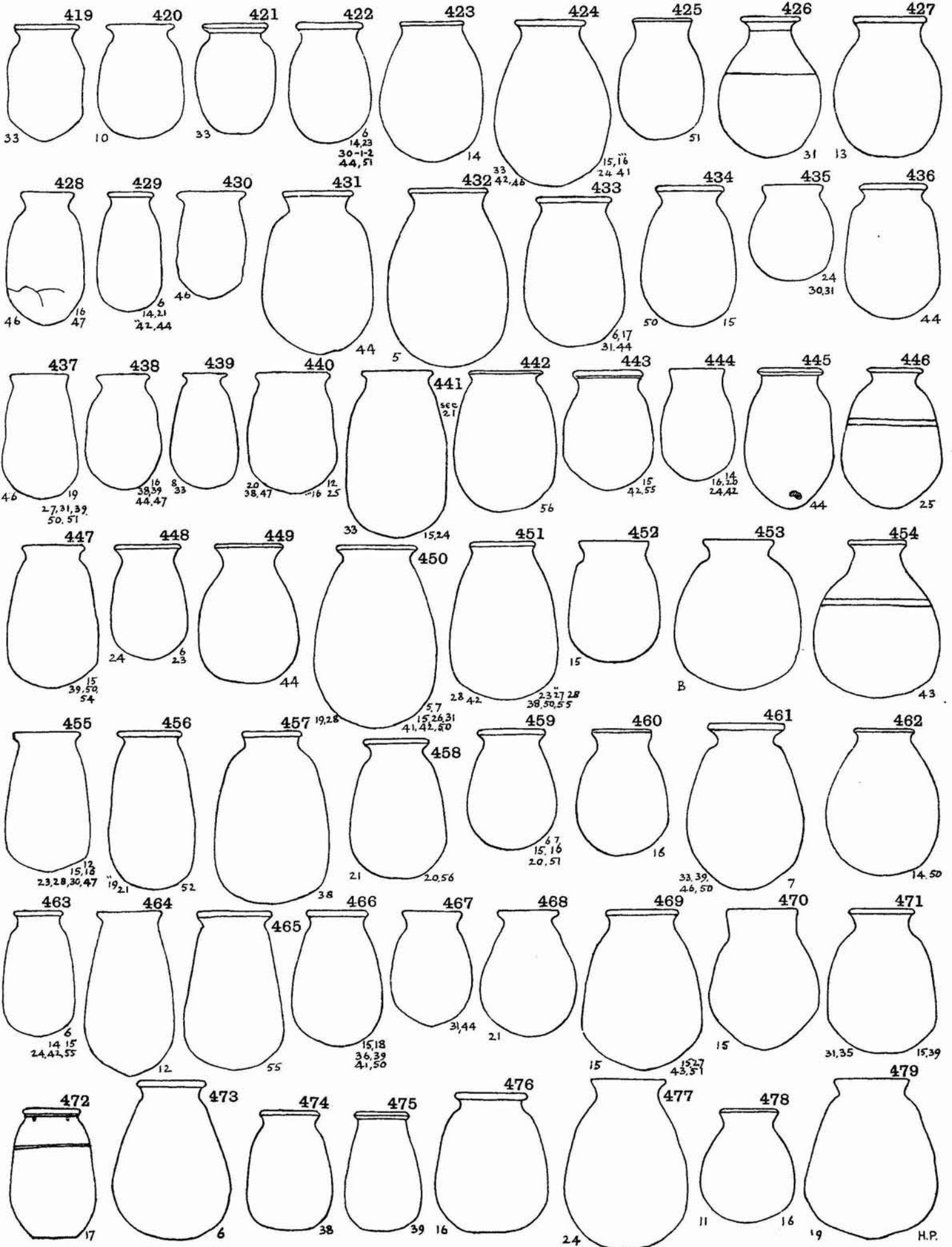

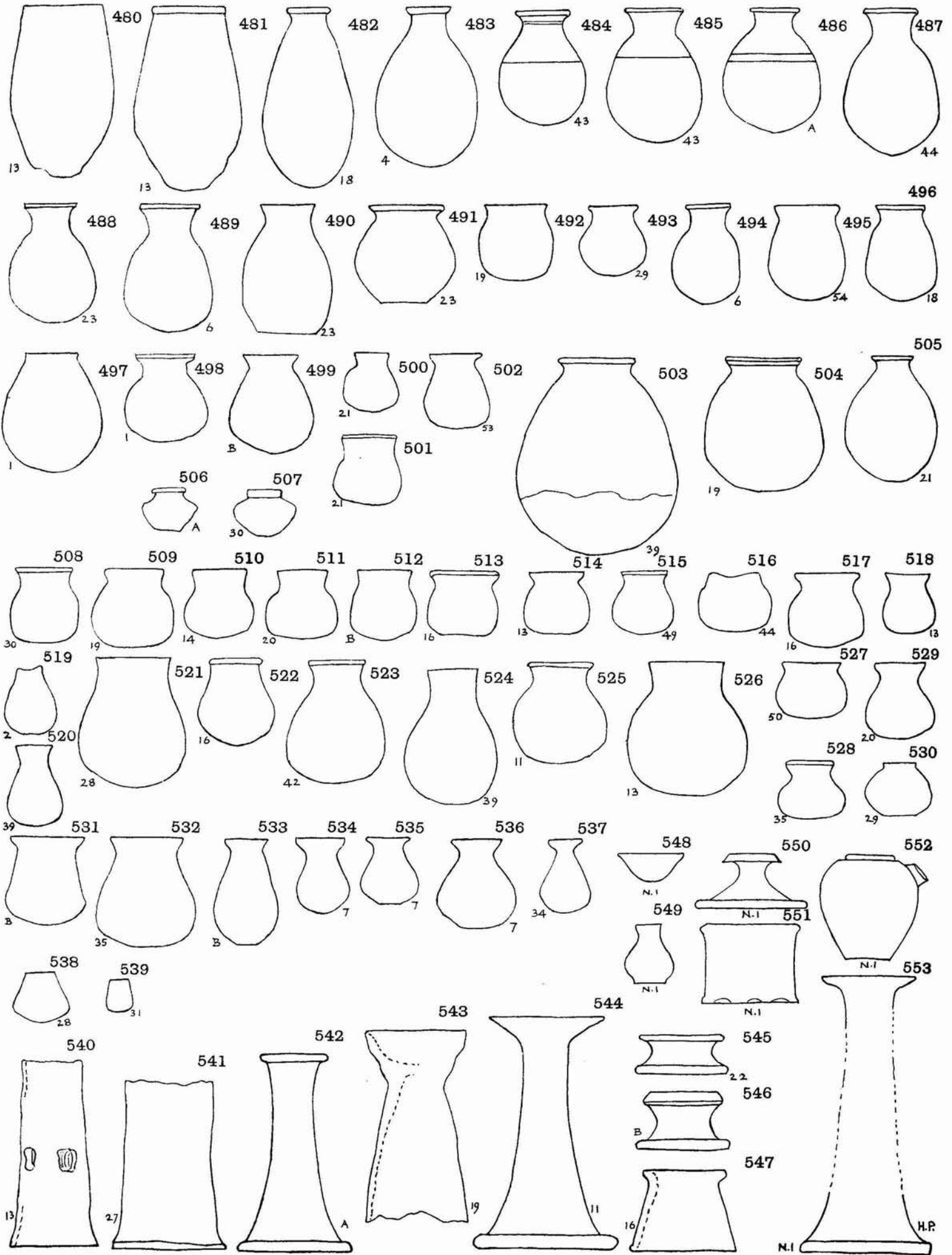

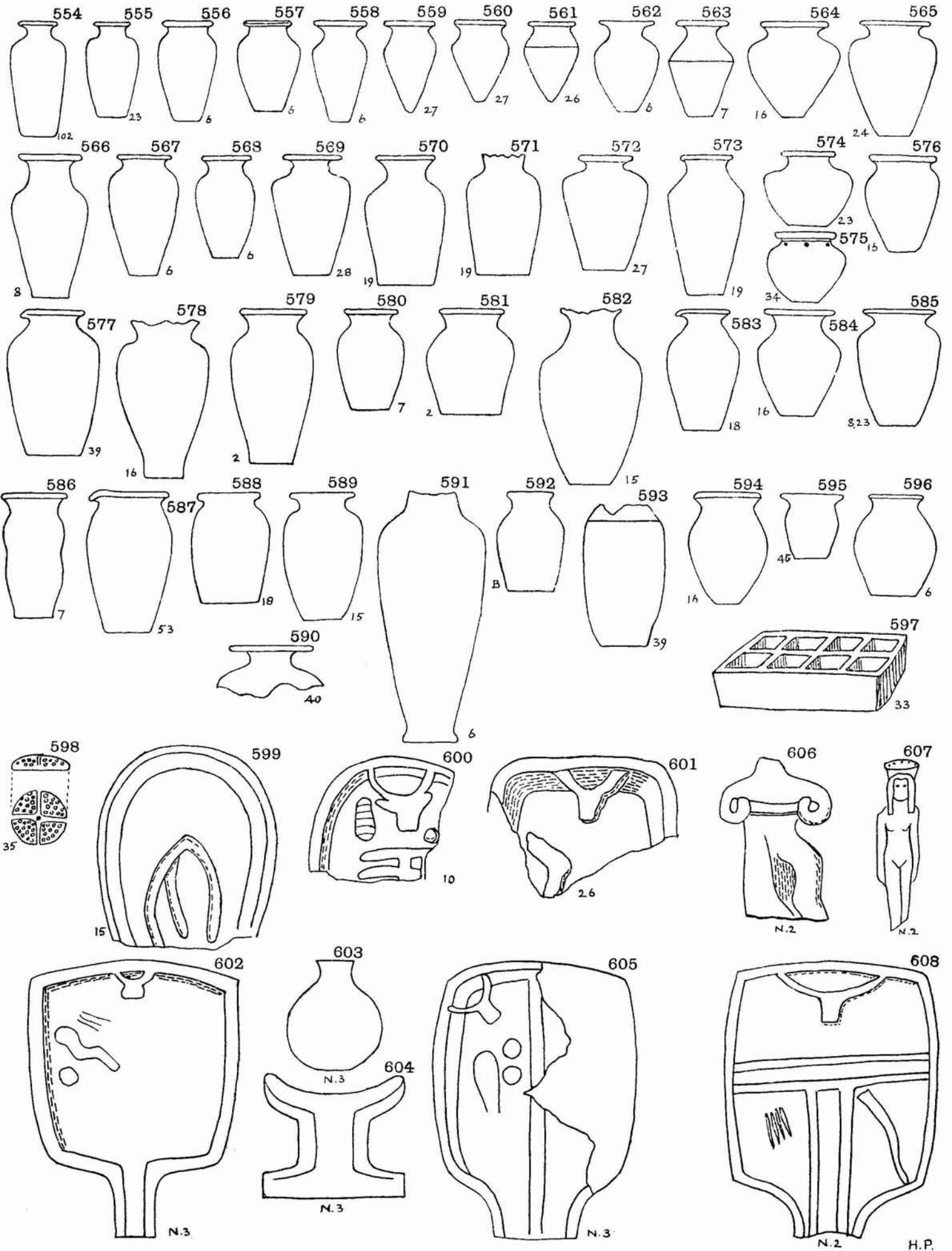

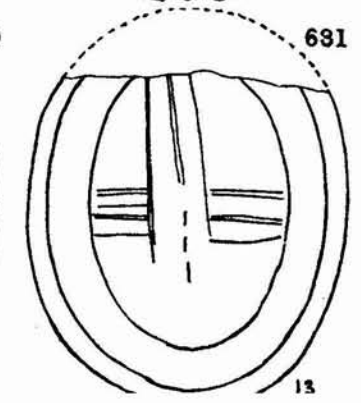
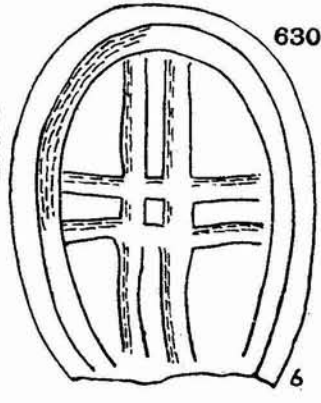
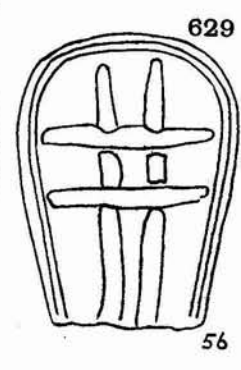
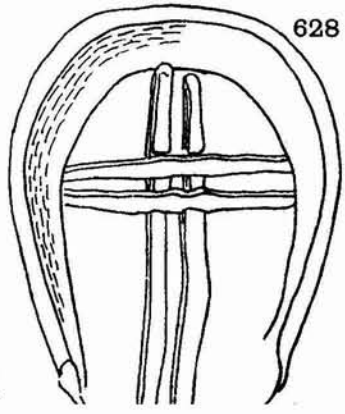
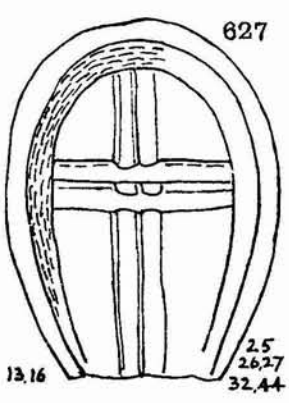
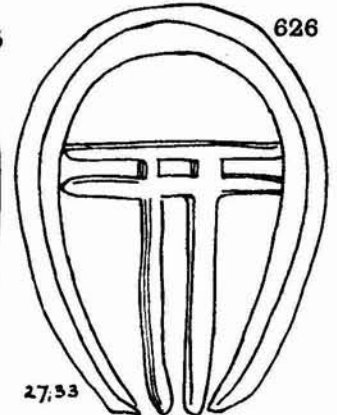
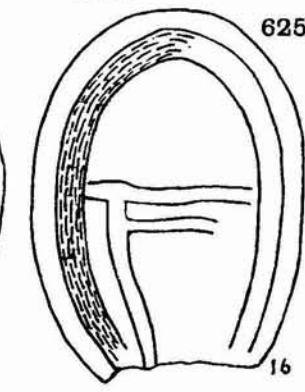
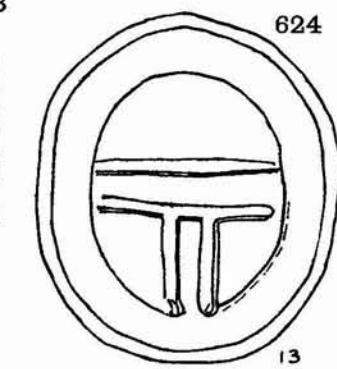
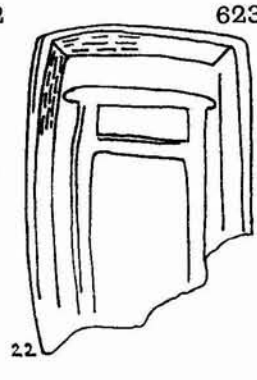
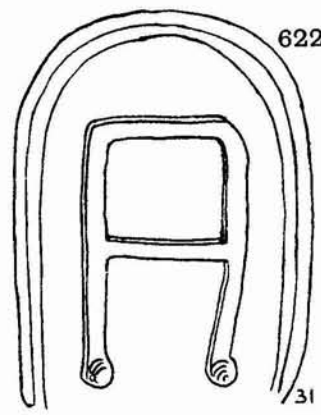
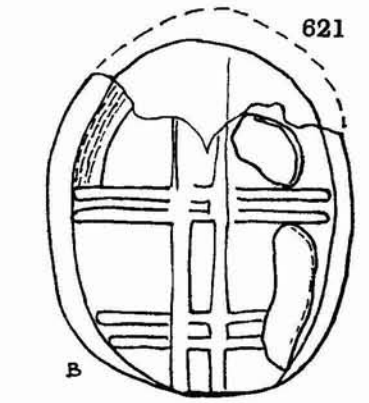
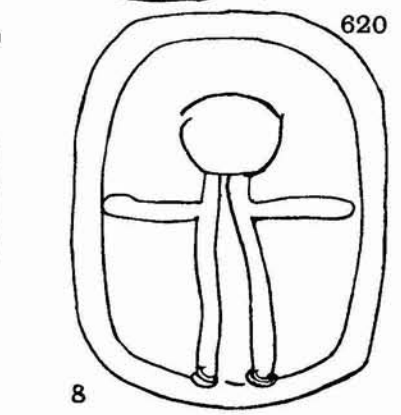
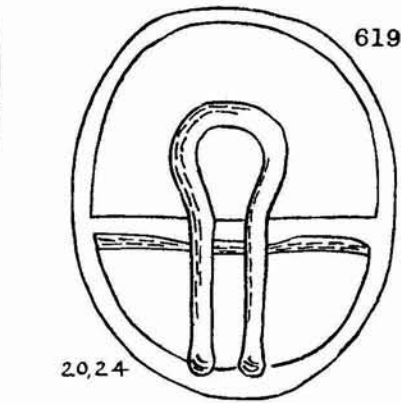
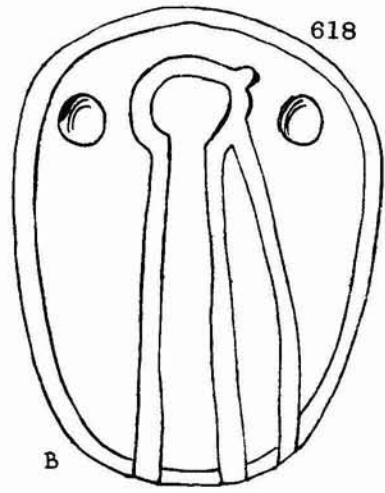
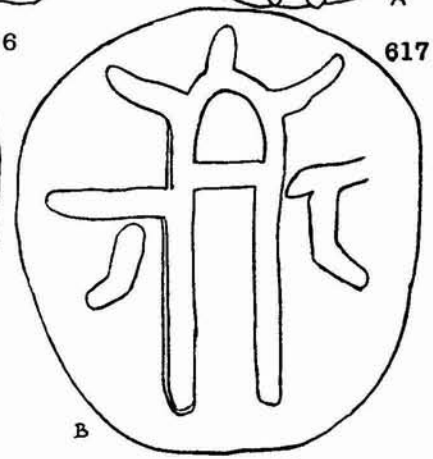
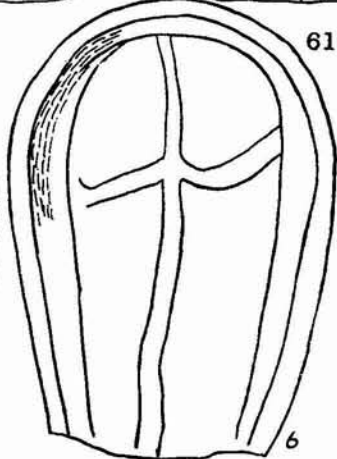
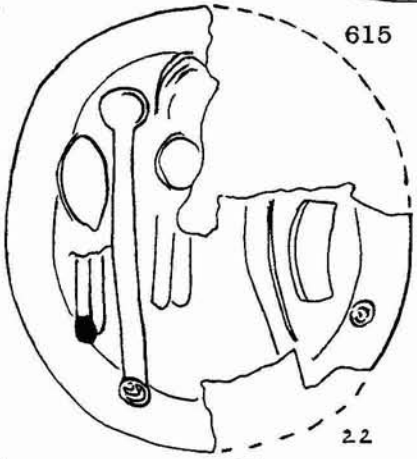
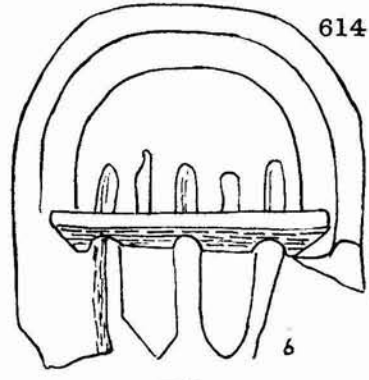
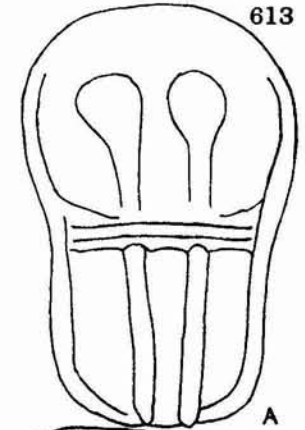
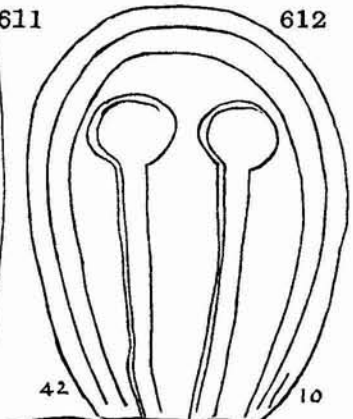
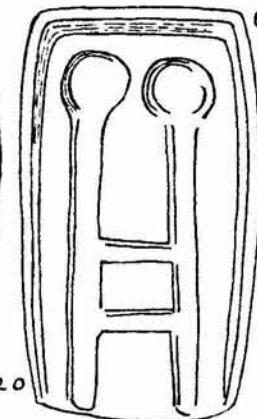
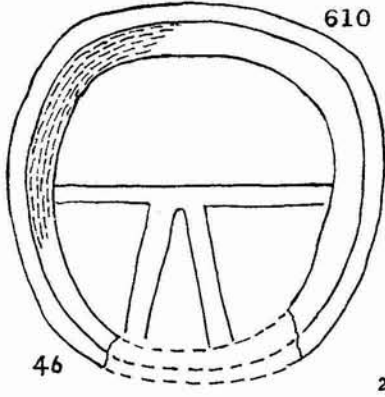
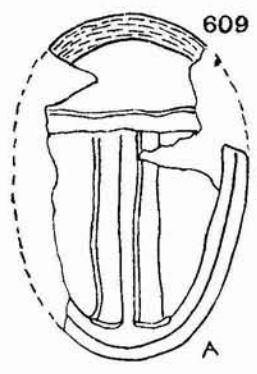

POTTERY 1:6

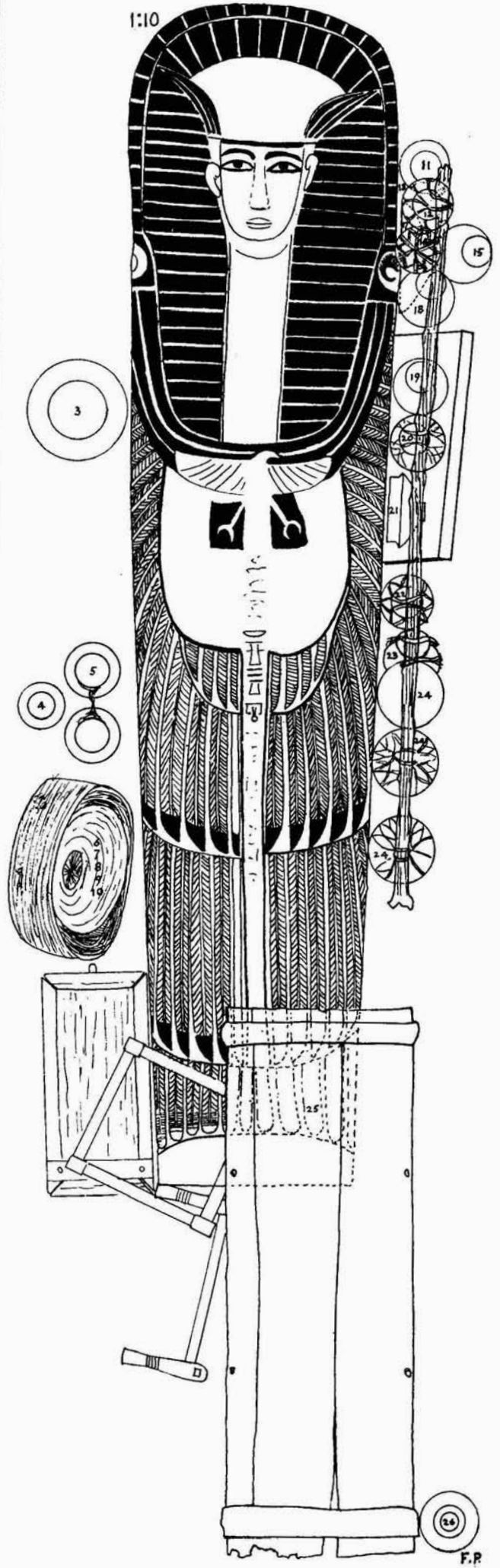
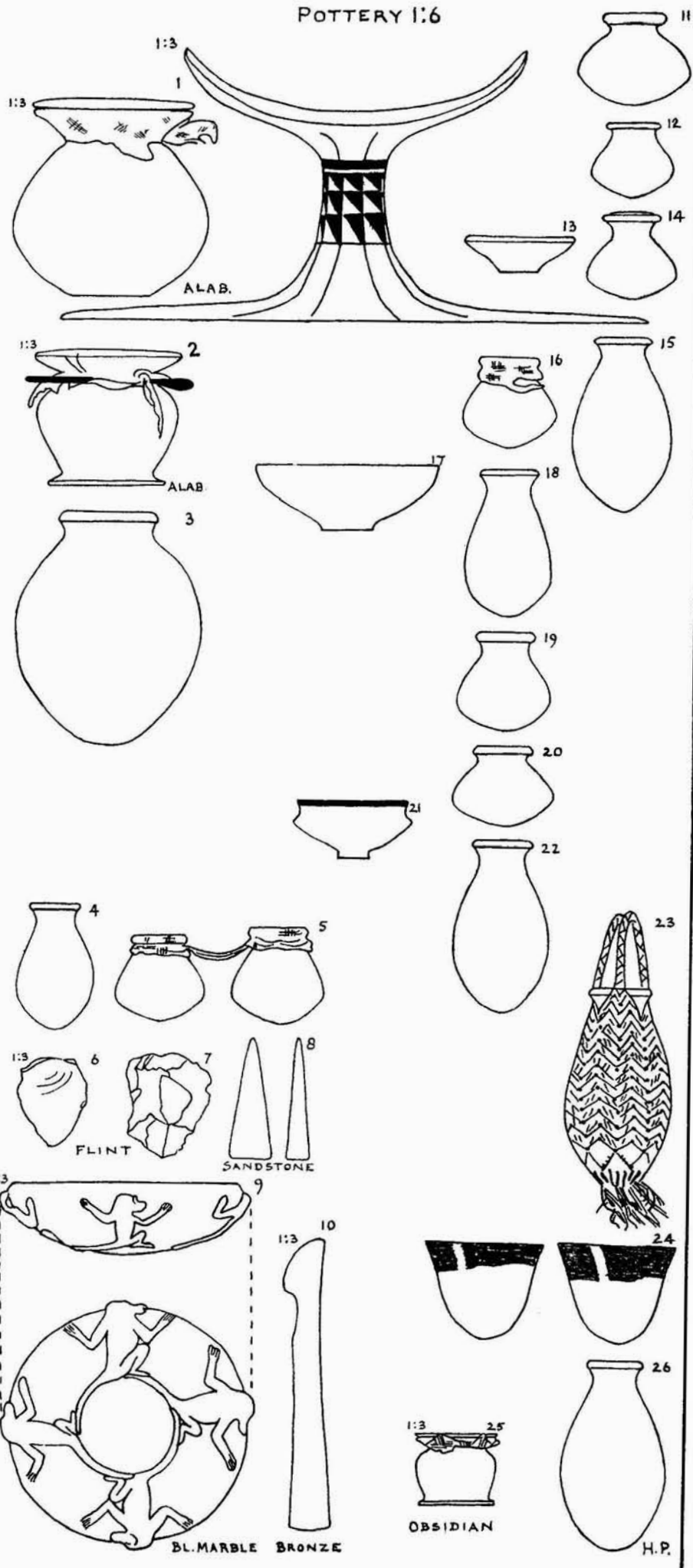

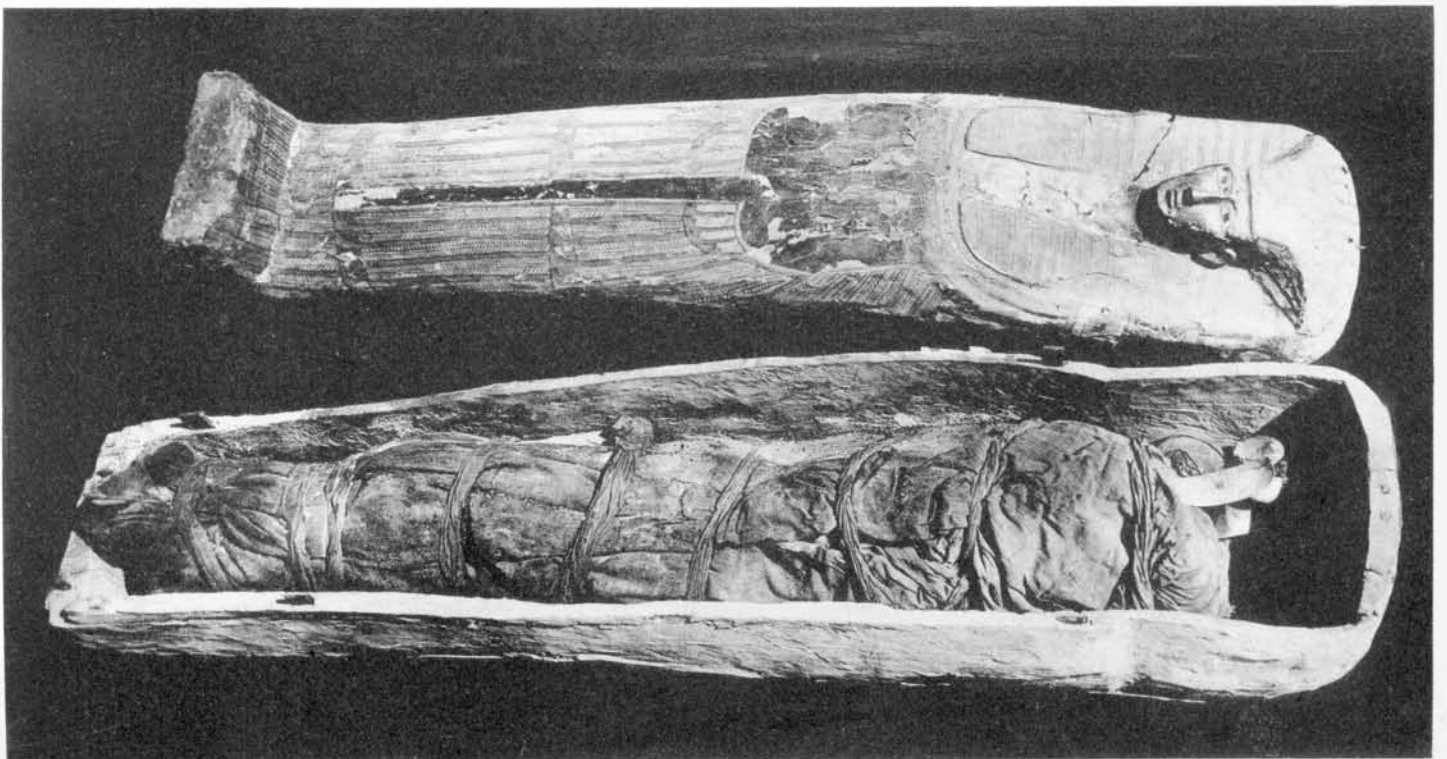



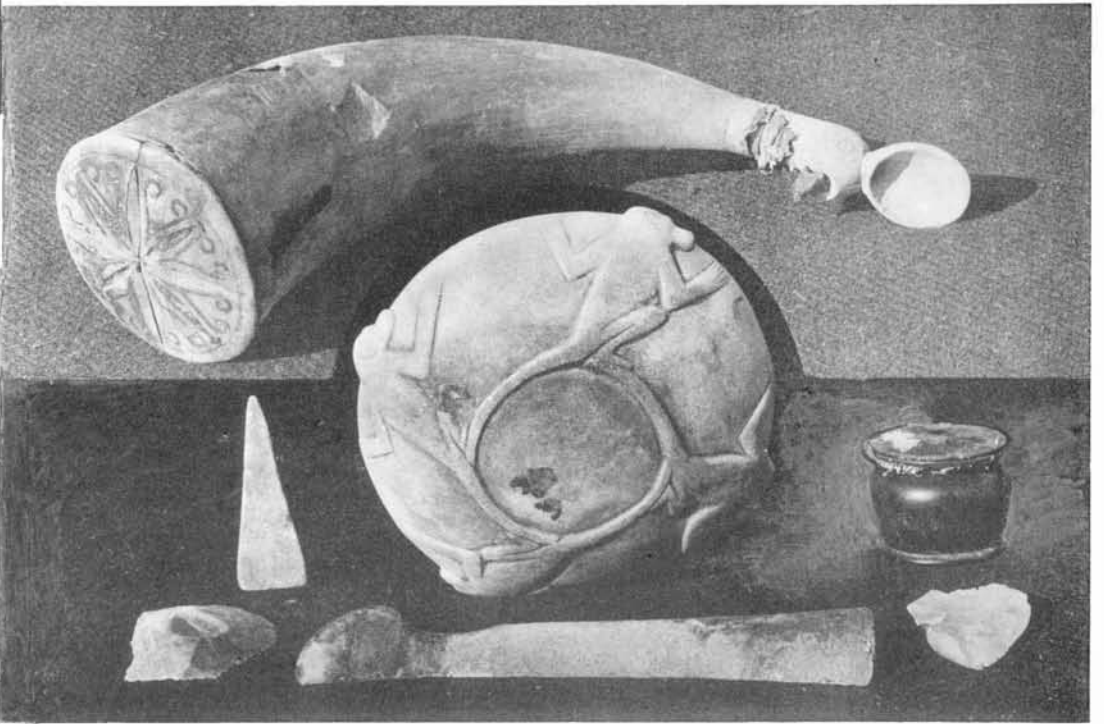
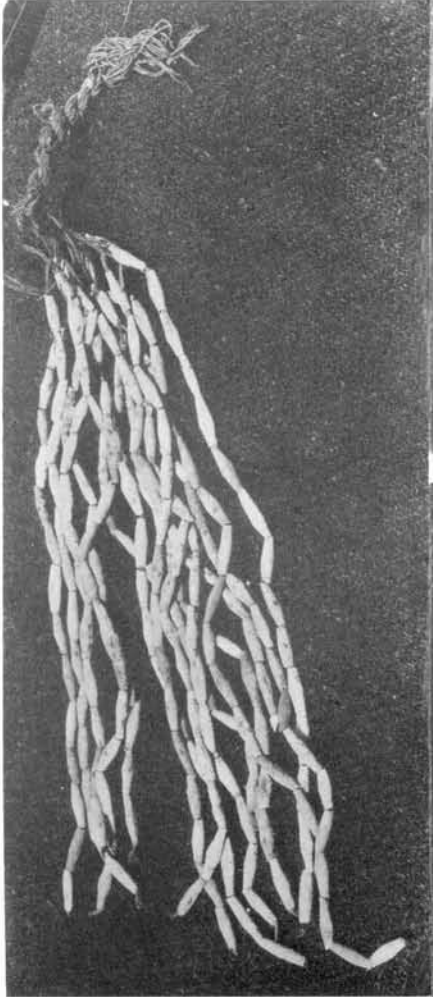
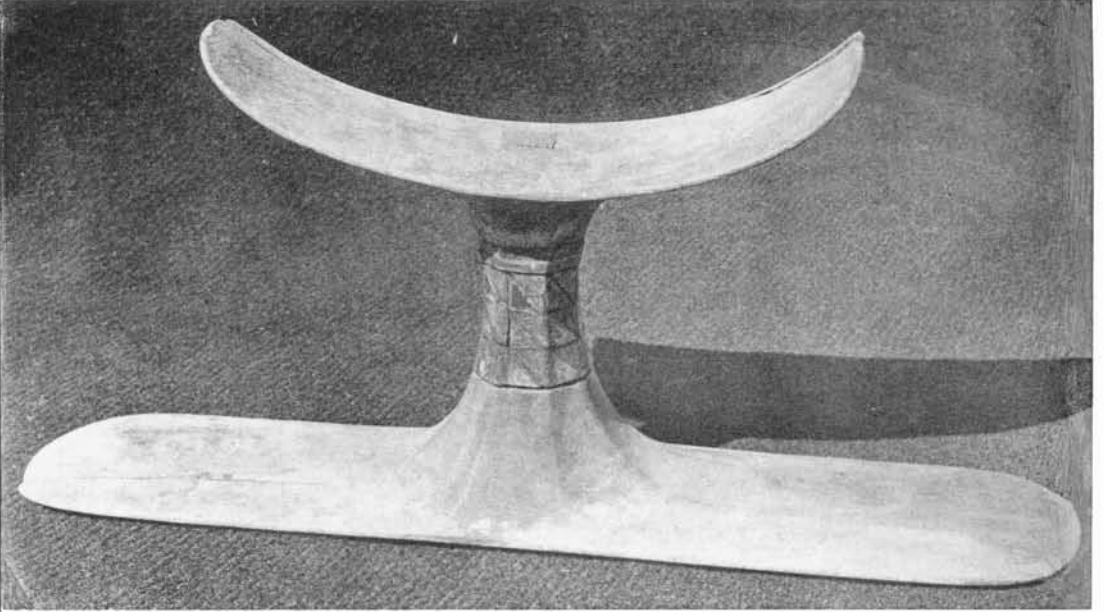
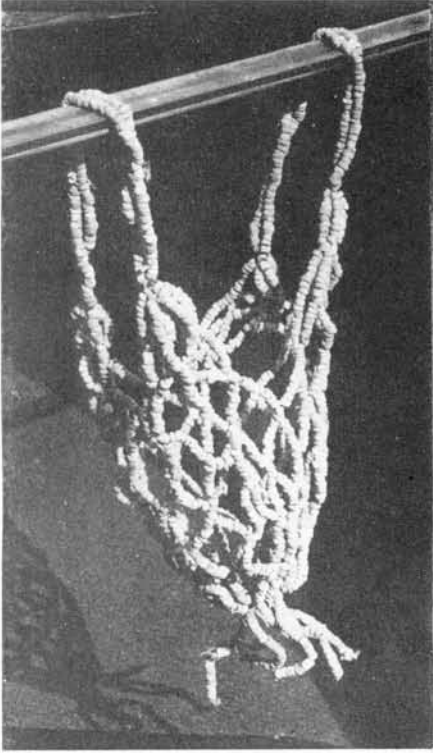

1:5



5:6

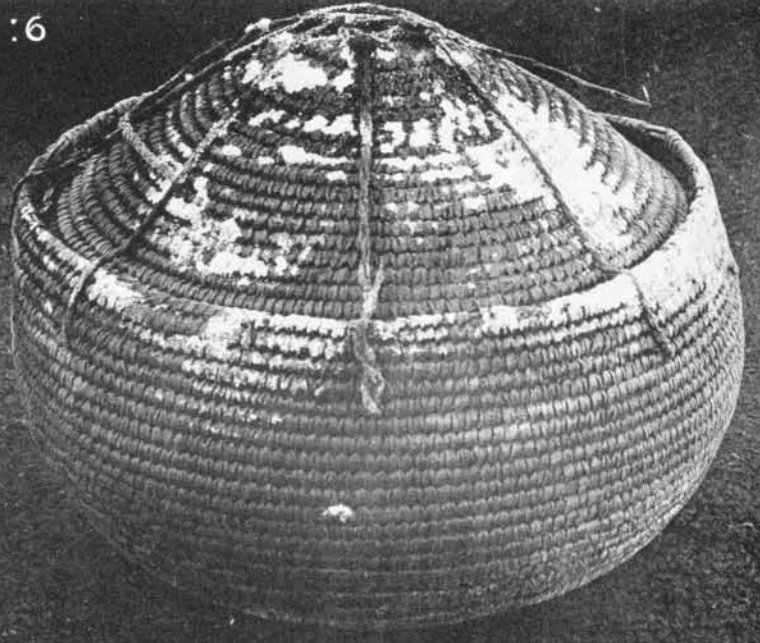

1:13



1:2

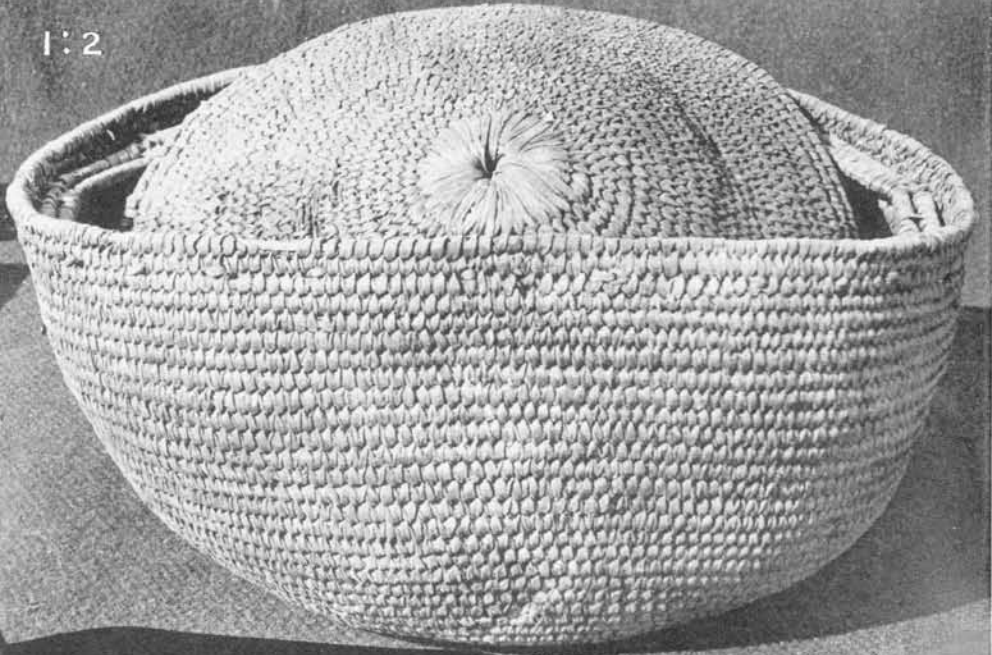

1:5

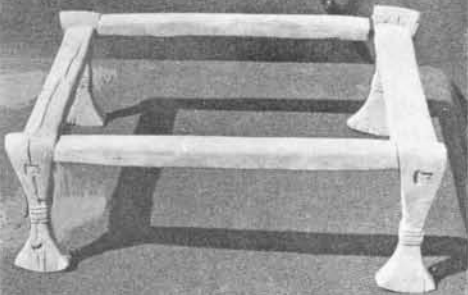

1:5



1:5

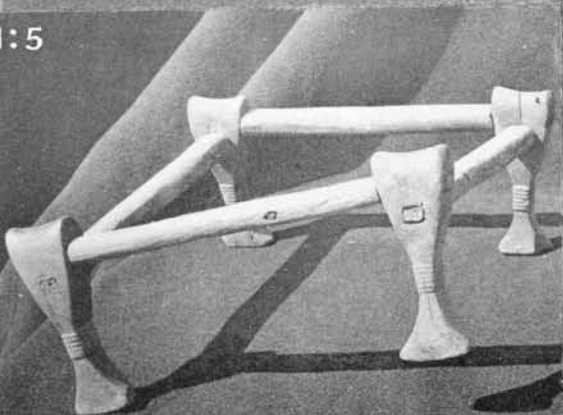

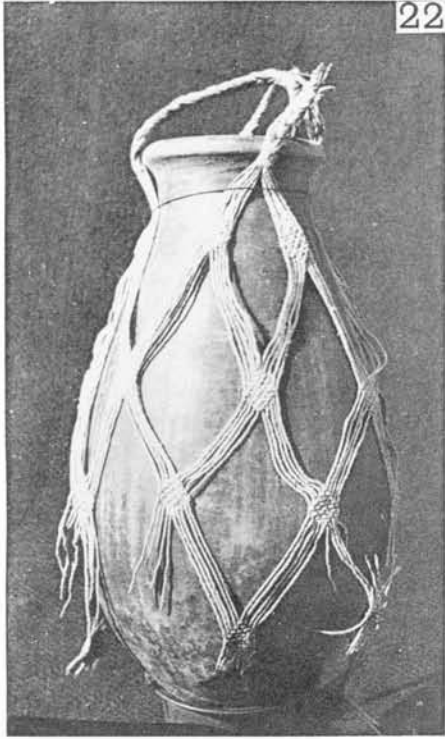

RED POTTERY.

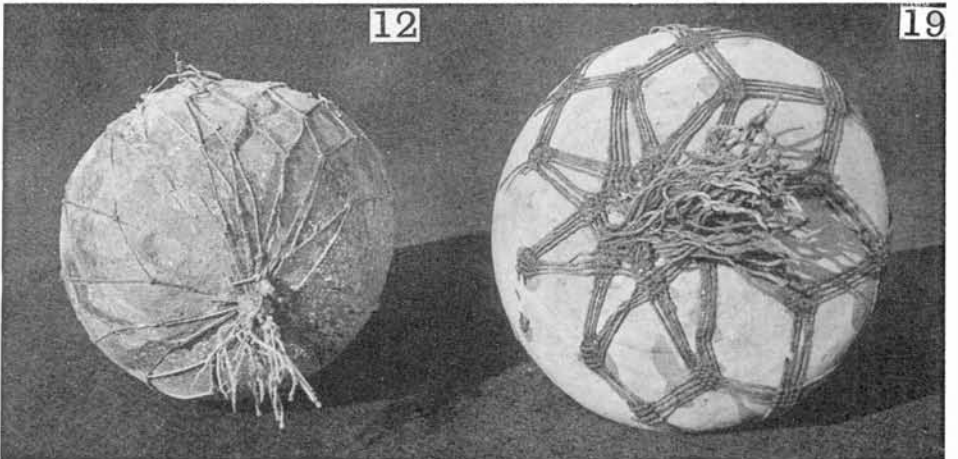
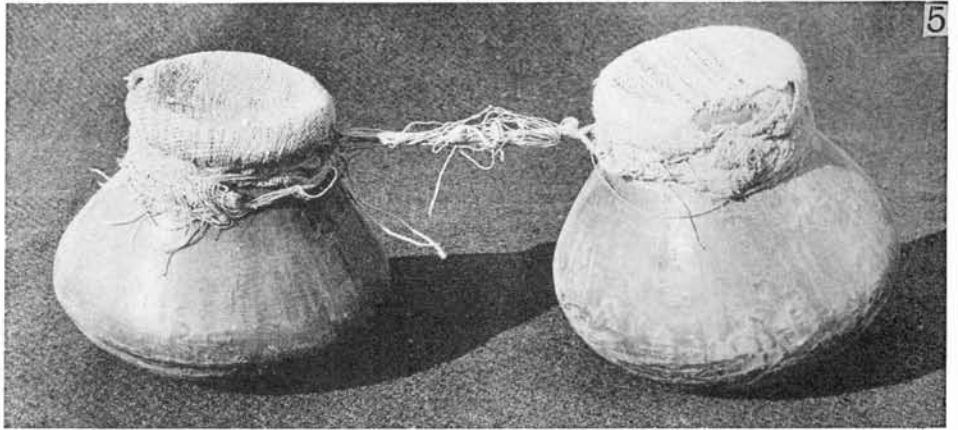
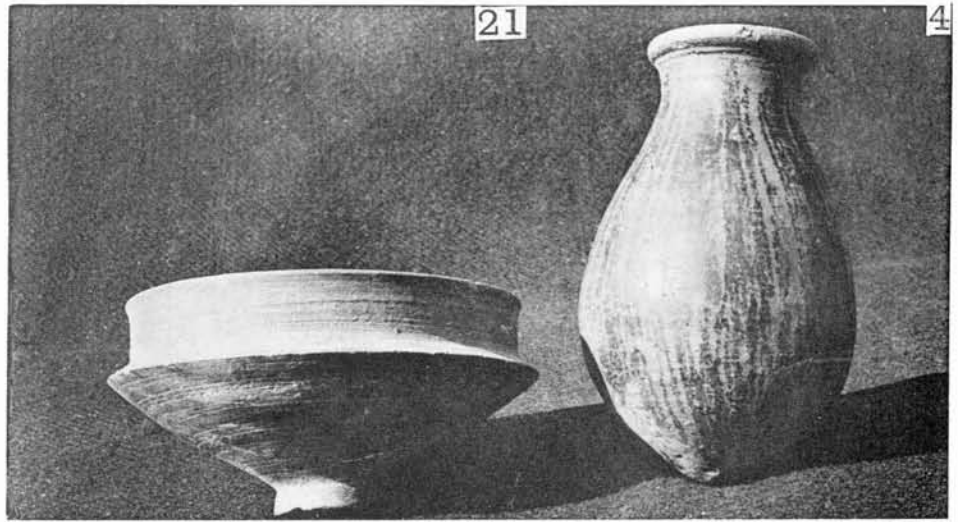

ALABASTER.

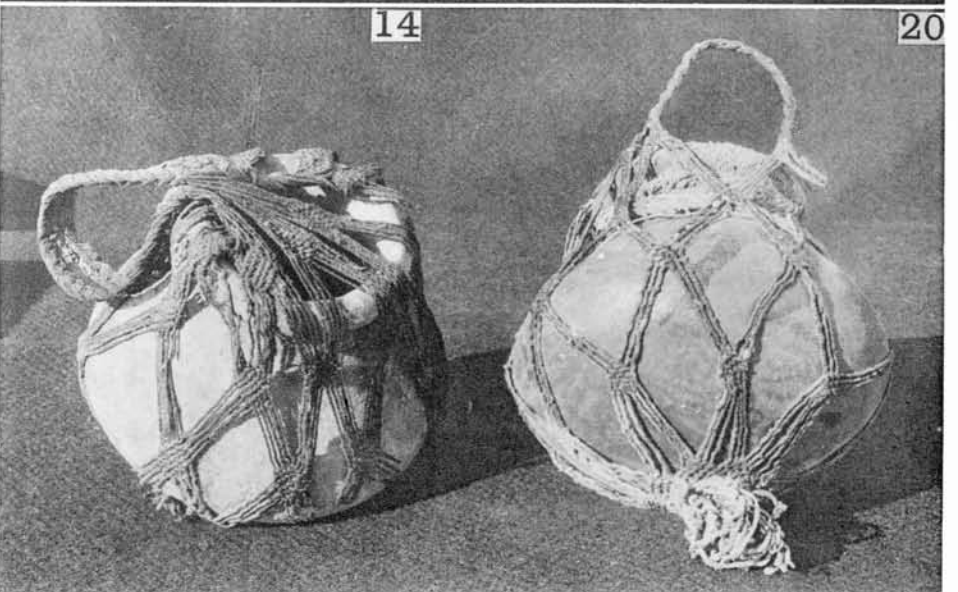

NUMBERS REFER TO PLATE XXII.

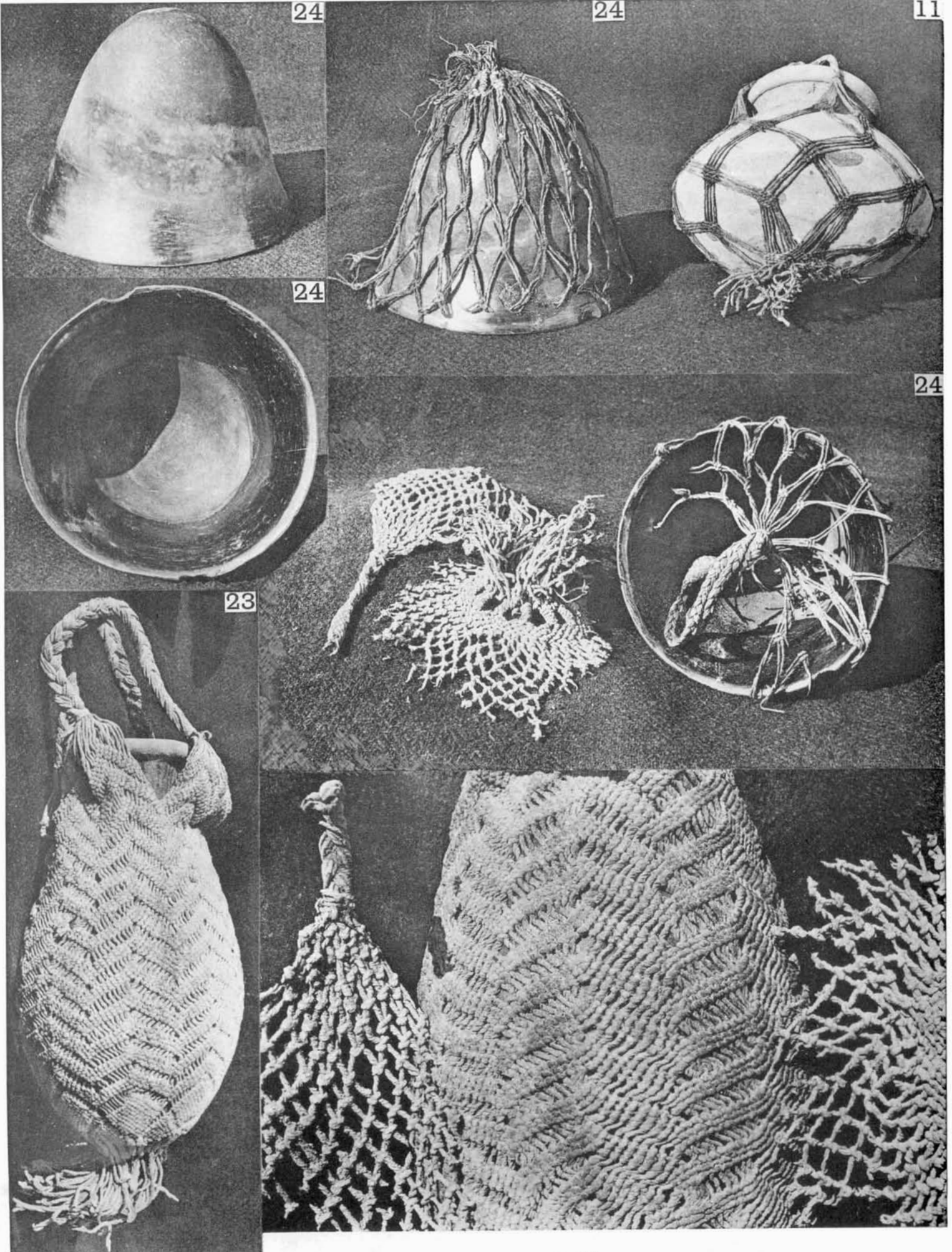

NUMBERS REFER TO PLATE XXII.

3:2

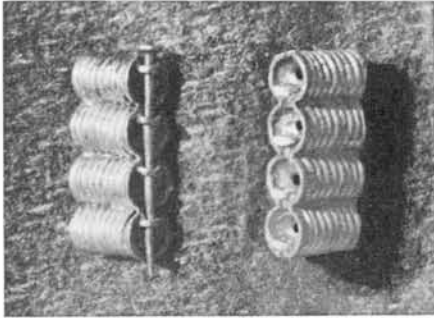

FASTENING OPEN.

3:2



SCARAB.



ELECTRUM BUTTON.

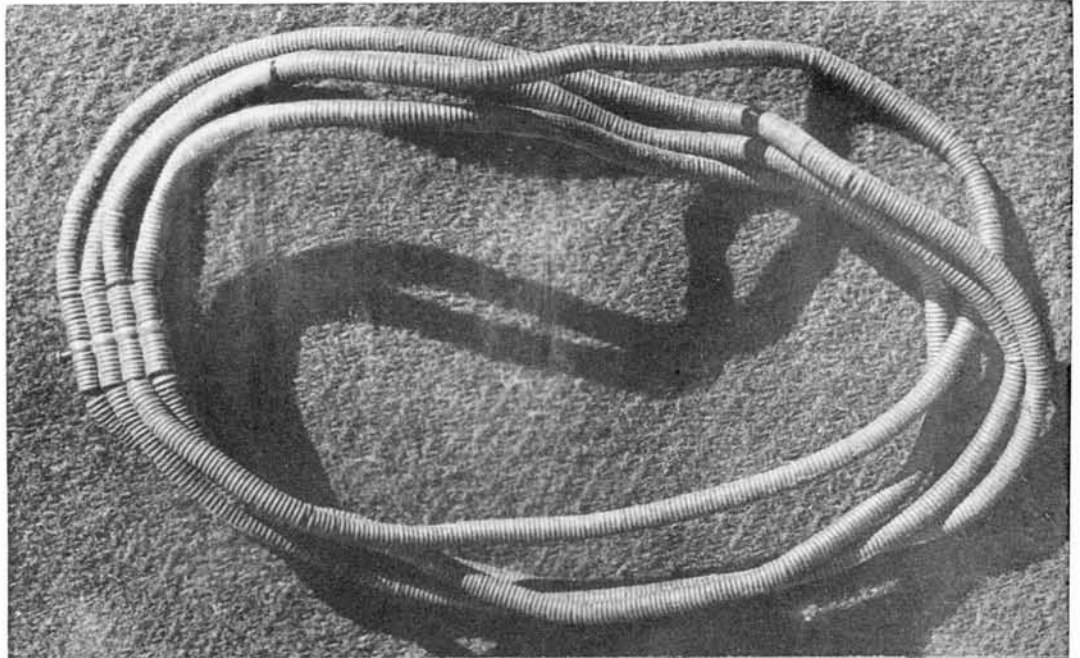

GOLD COLLAR, BANGLES, AND EAR-RINGS.

WEIGHTS.

—o—

GRAINS.

Collar	- -	1585.4	20 × 79.3
Bangles	- -	322.7	4 × 80.7
		324.4	4 × 81.1
		325.6	4 × 81.4
		325.8	4 × 81.4
Ear-rings	- -	133.8	
		138.8	
Button	- -	11.7	
Girdle	- -	352	
		3520	

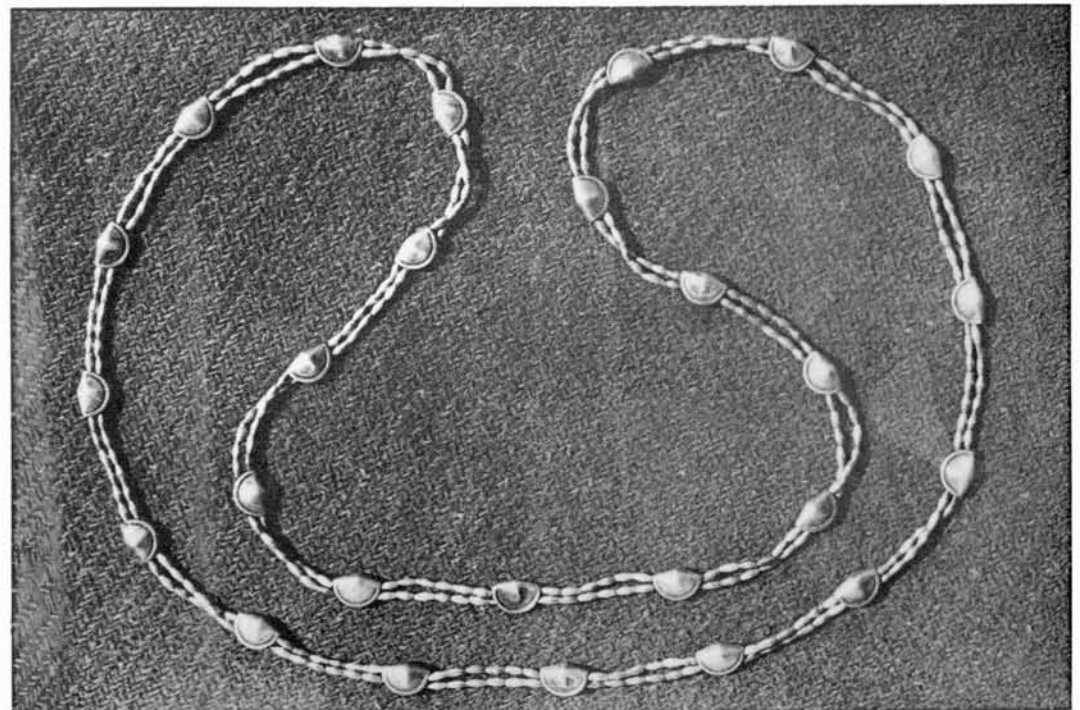

ELECTRUM GIRDLE.

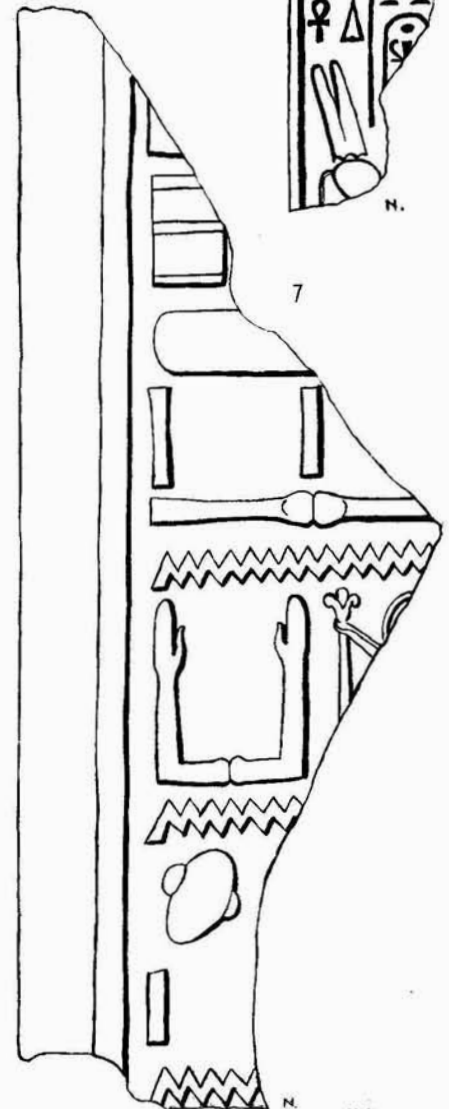
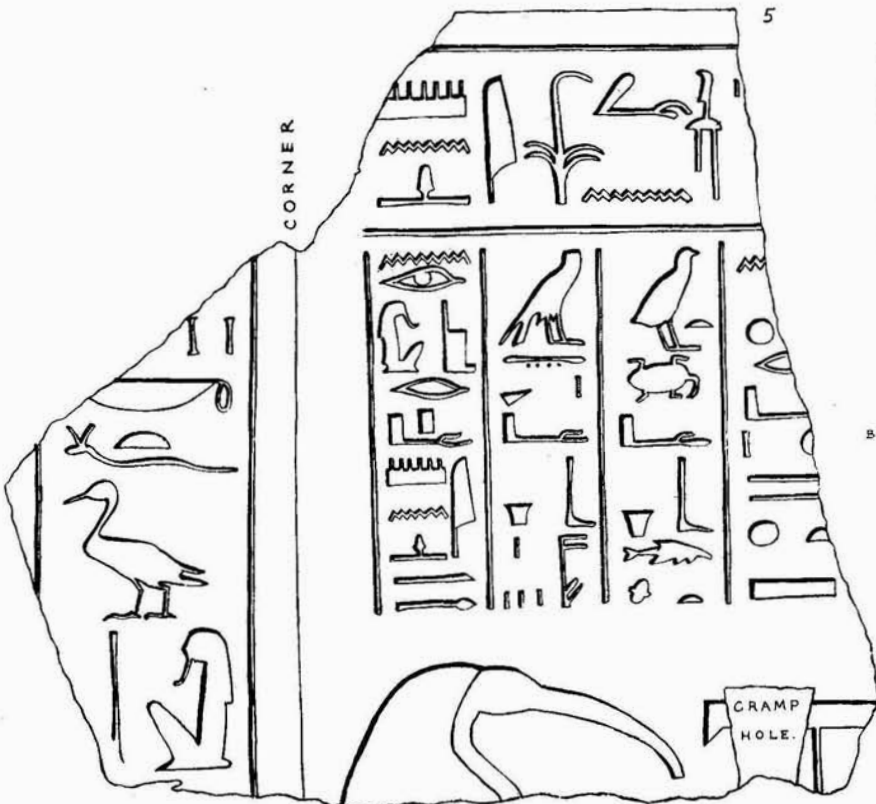
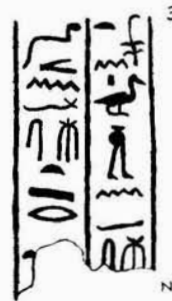
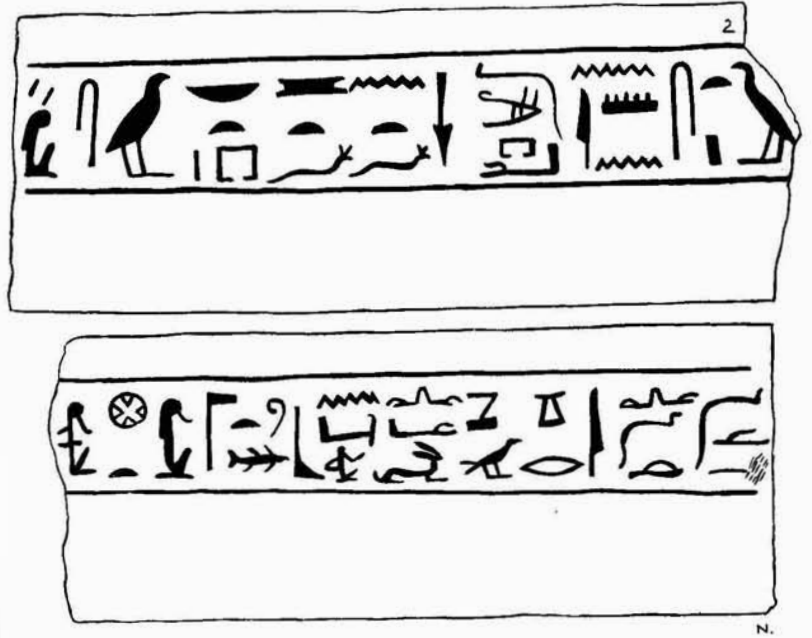
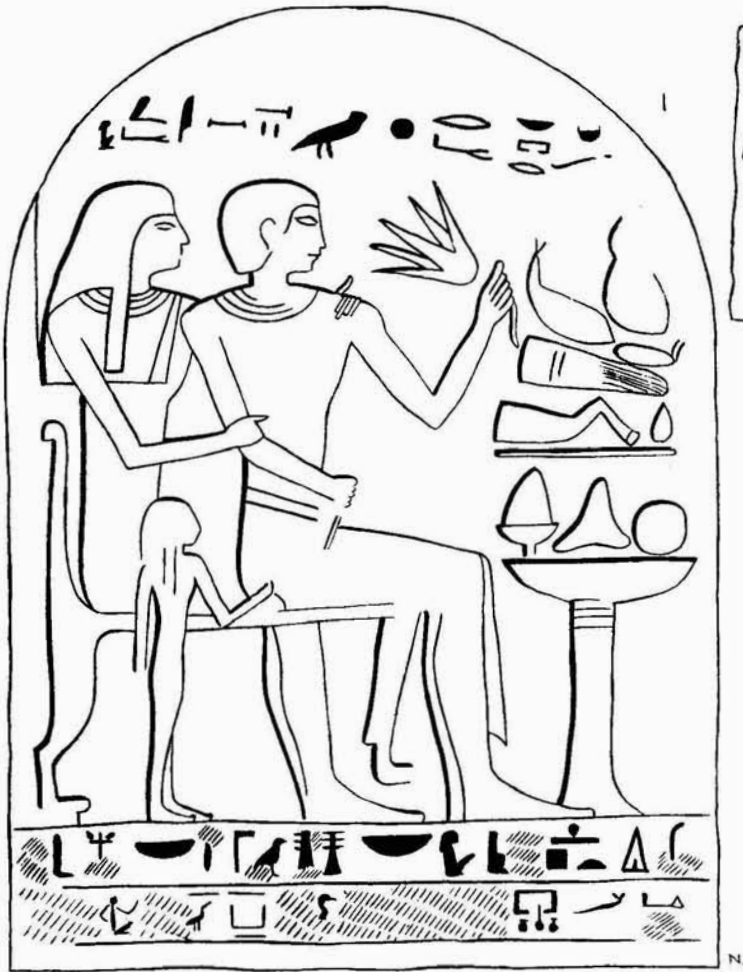

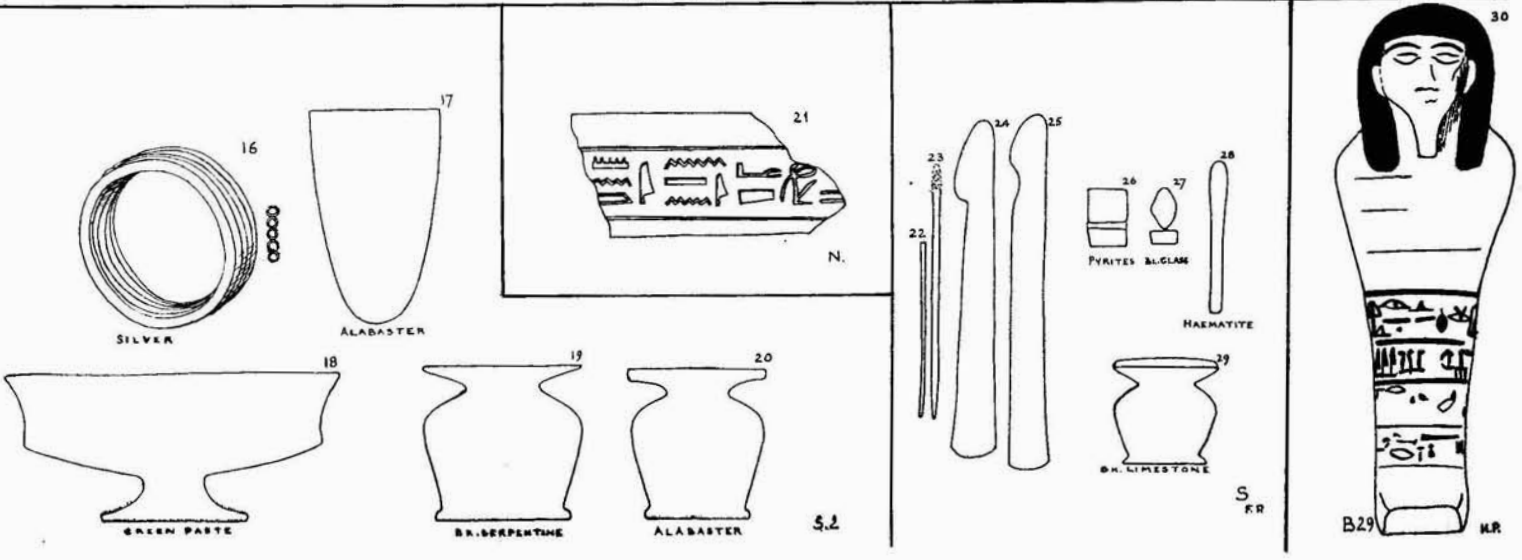
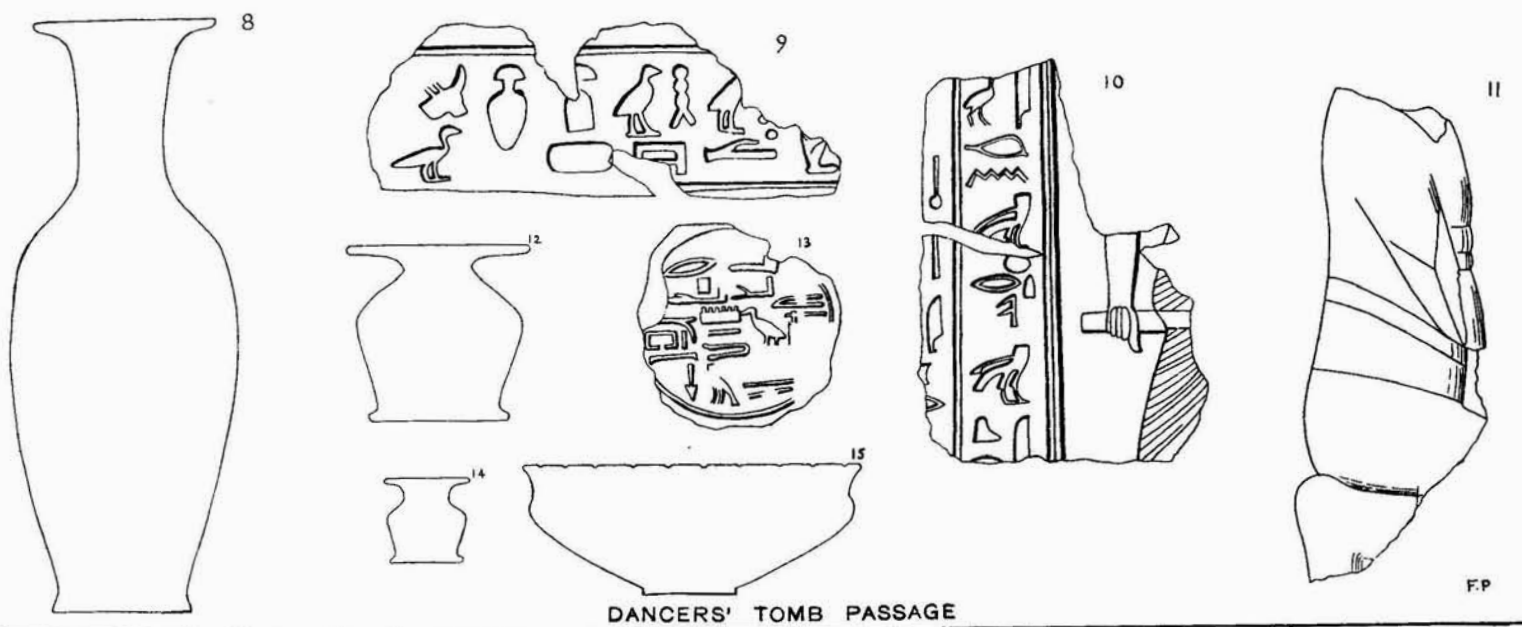
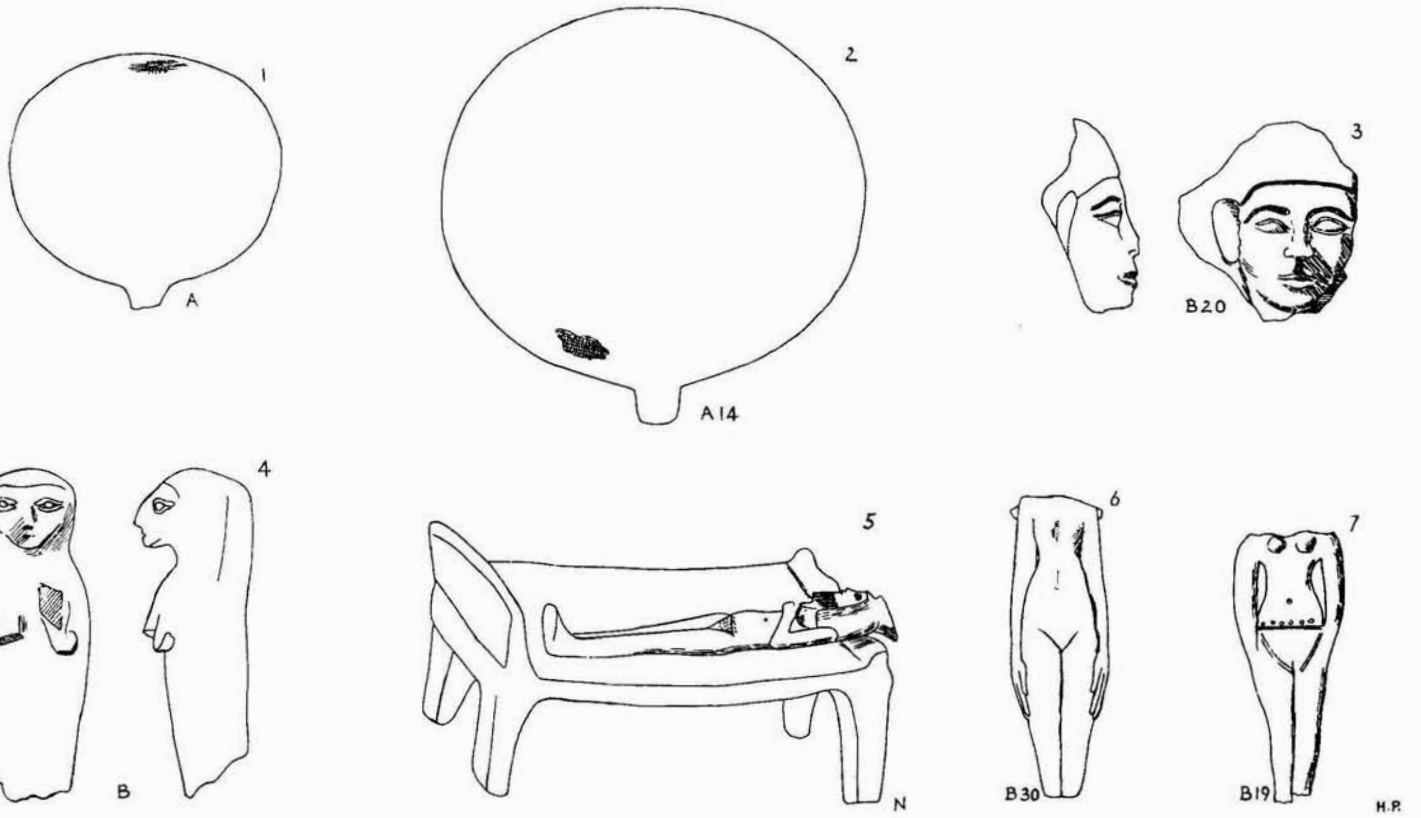

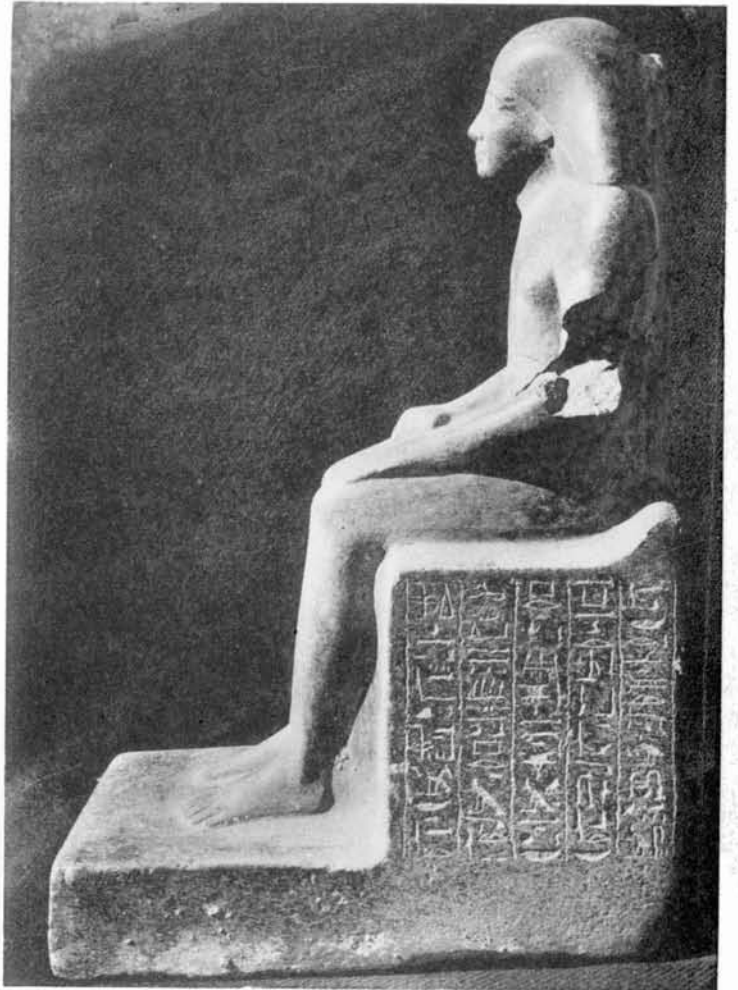
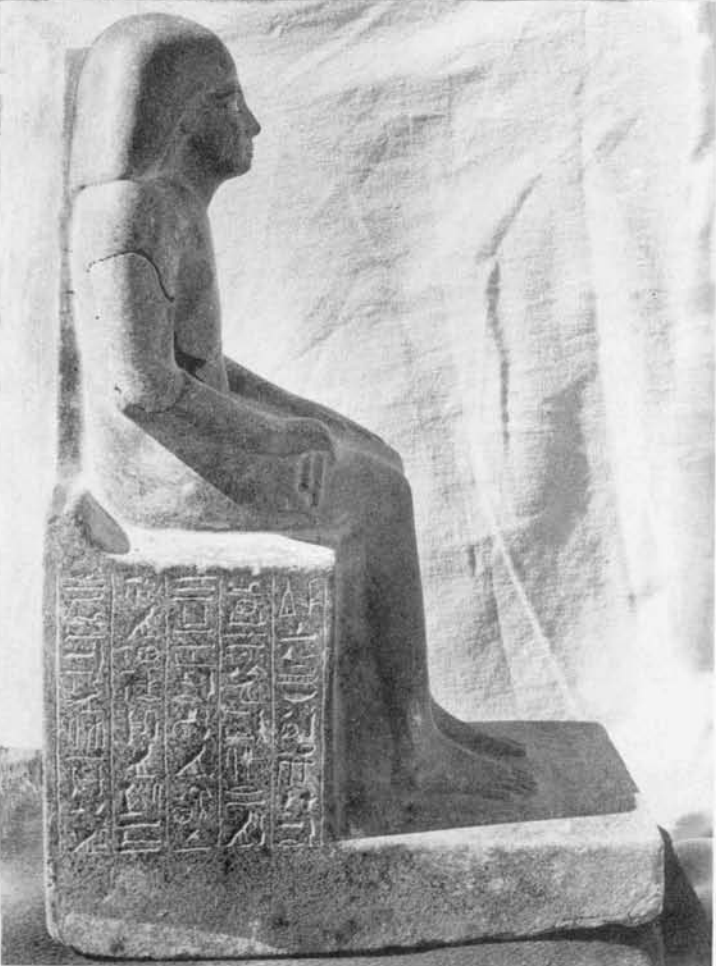



LIMESTONE FIGURE.

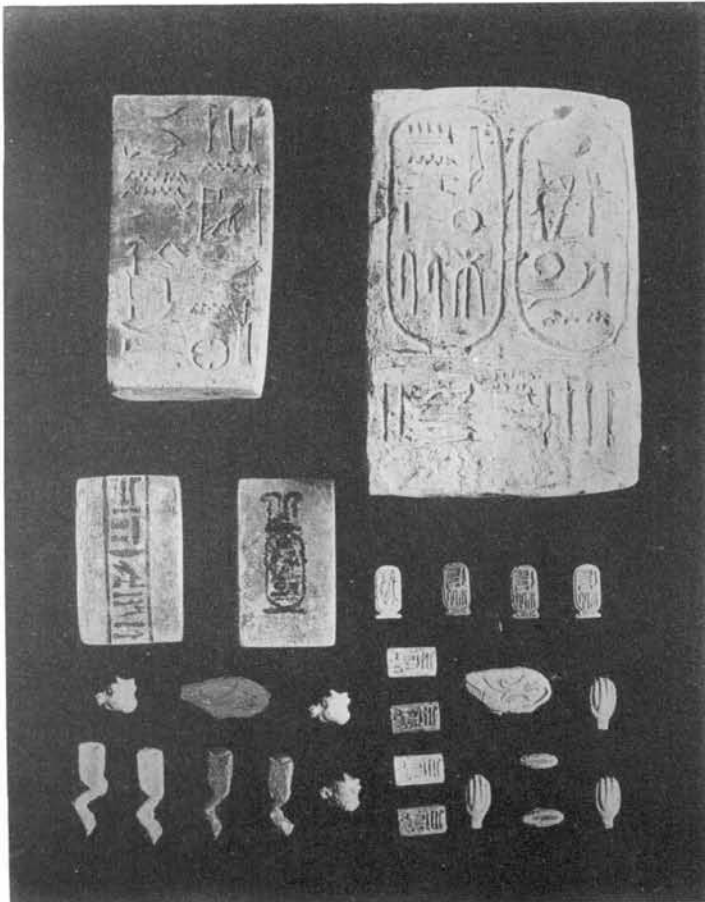

FOUNDATION DEPOSIT OF NEBUNNEF.



TRIAL PIECE.



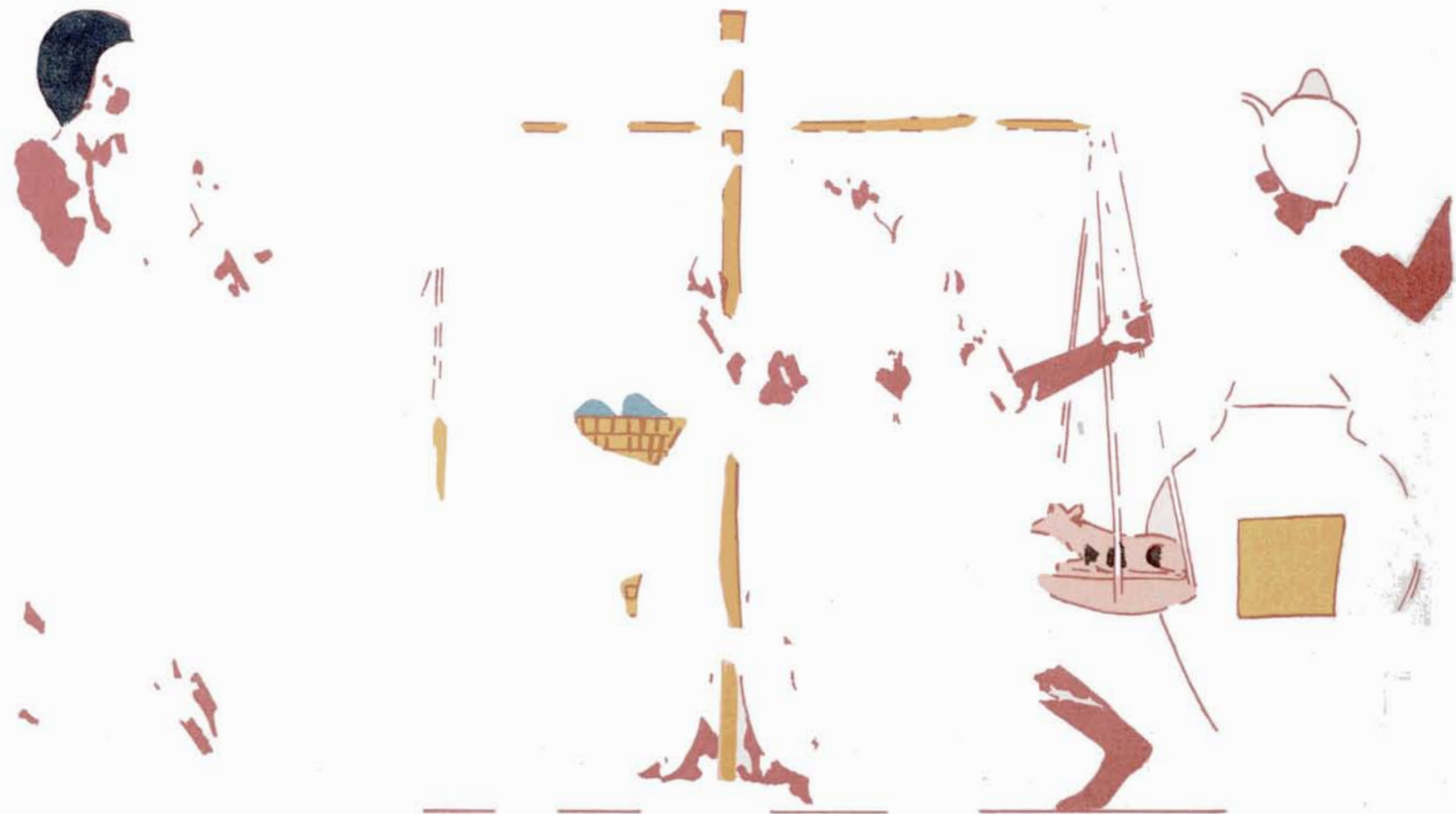
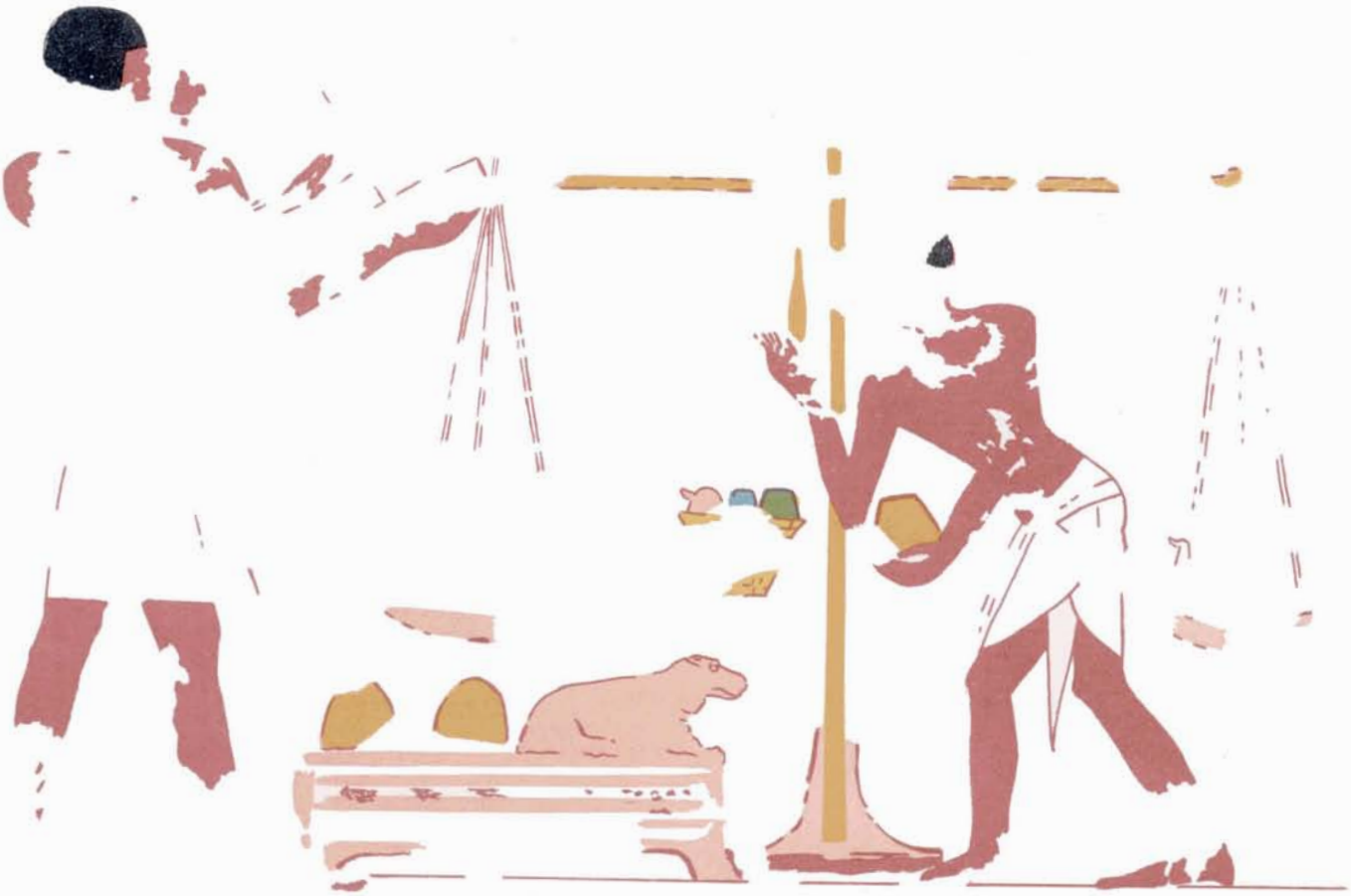



210
↓

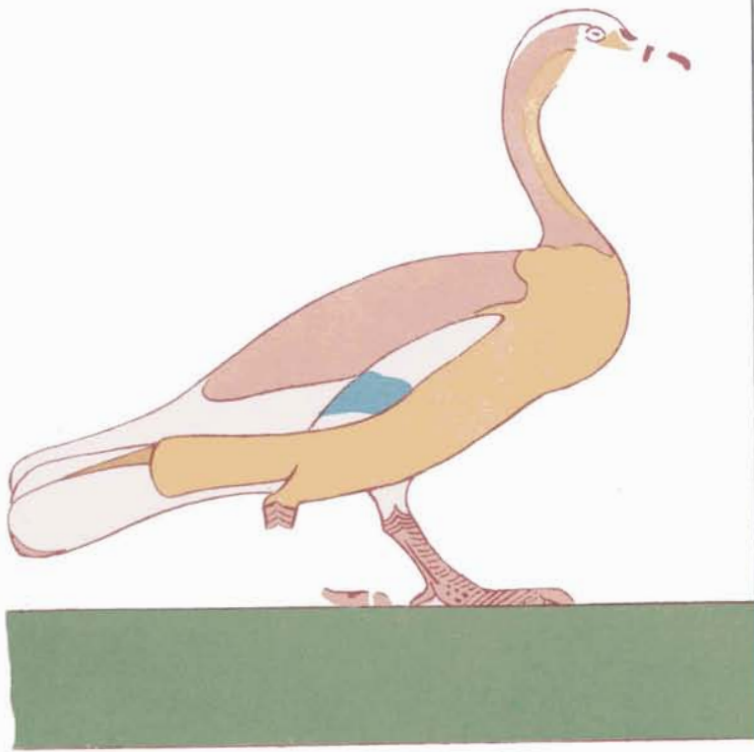

TARO.

E. WALL, N. HALF.



W. WALL, N. HALF.



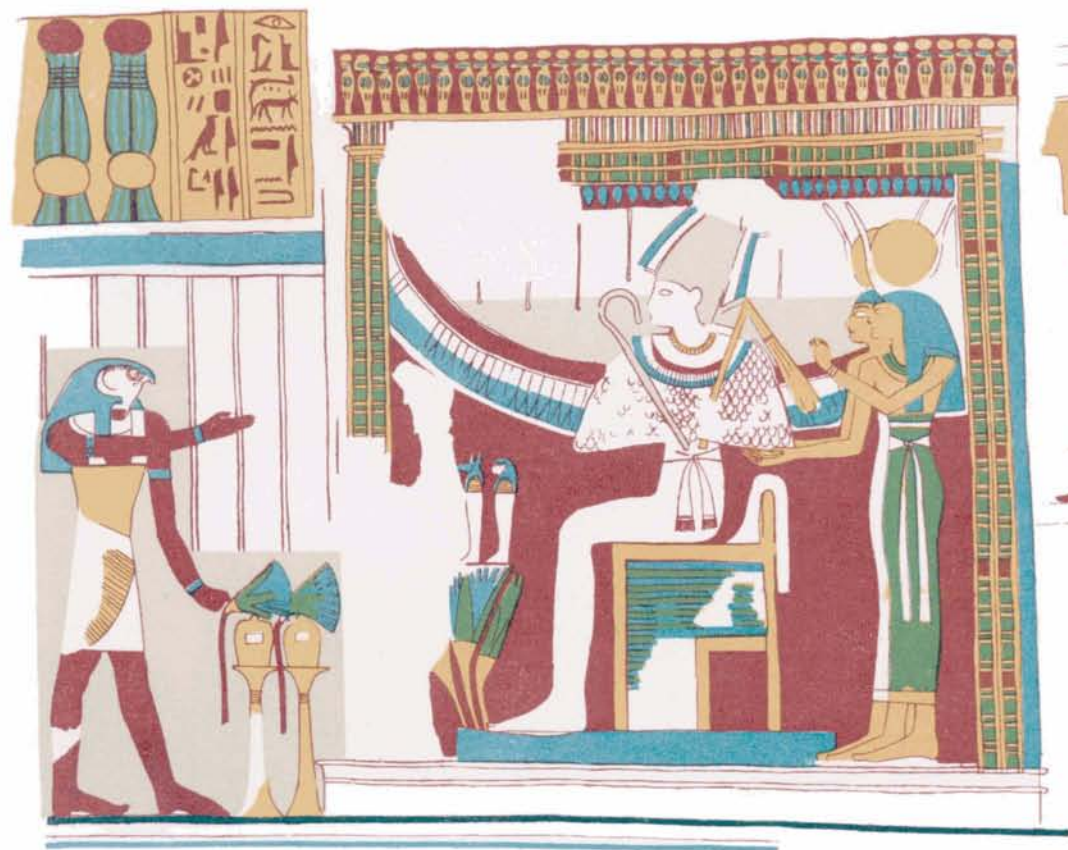

A. 9.
PROBABLY XI
WITH No 637 of XVIII

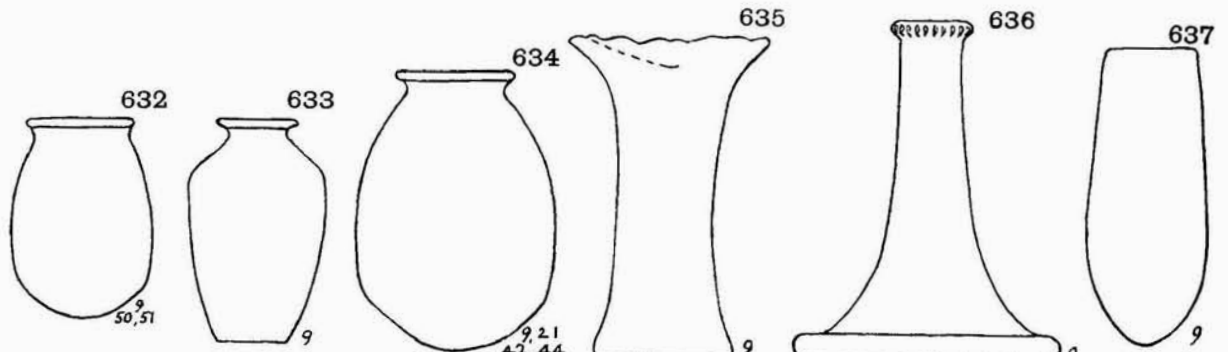

B. 3.
MAINLY XVIII
WITH No 645 of XI

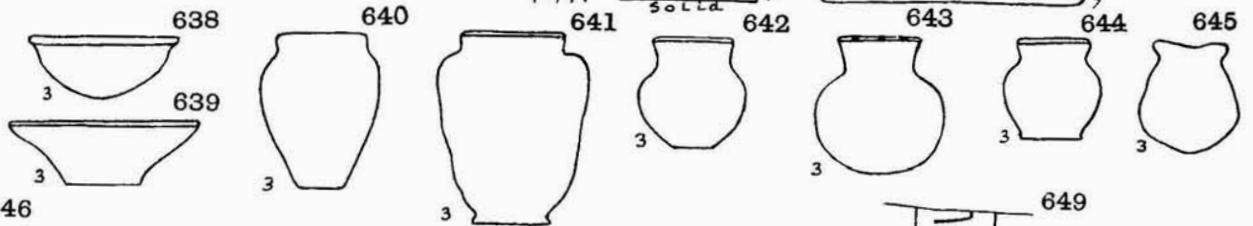

N. 5.
UNDER NEBUNNEF TEMPLE

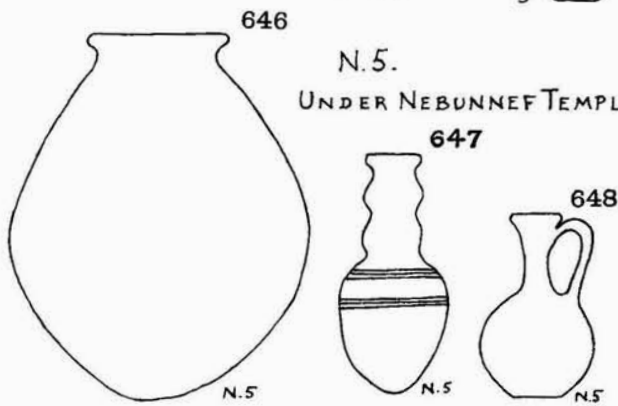

K
TOMB WELL
NEXT TO BAKA.

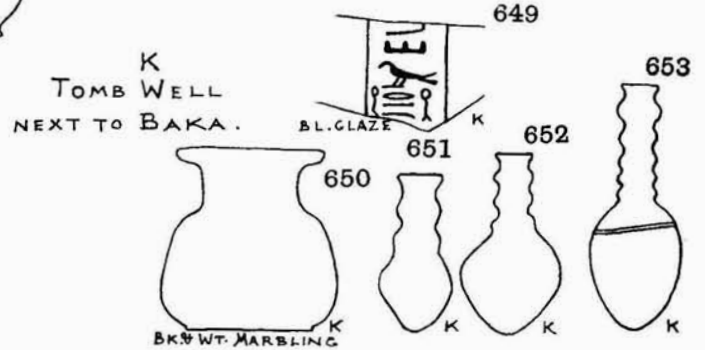

N. 6. UNDER
NEBUNNEF TEMPLE.

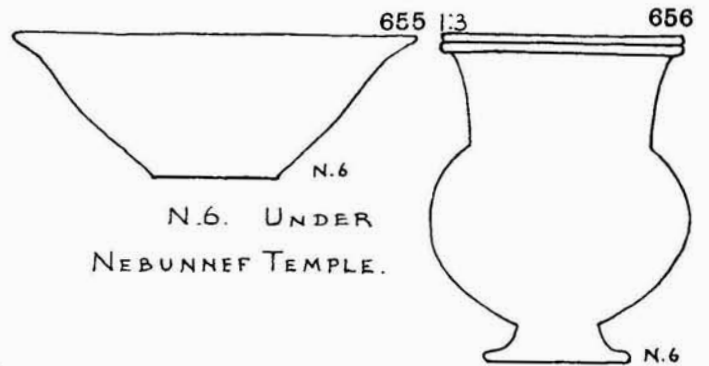

POTTERY BOX
UNDER NEBUNNEF TEMPLE
WITH KHAUIY CONES.

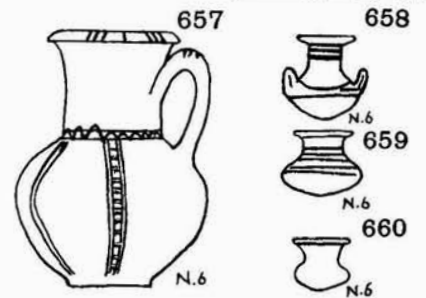
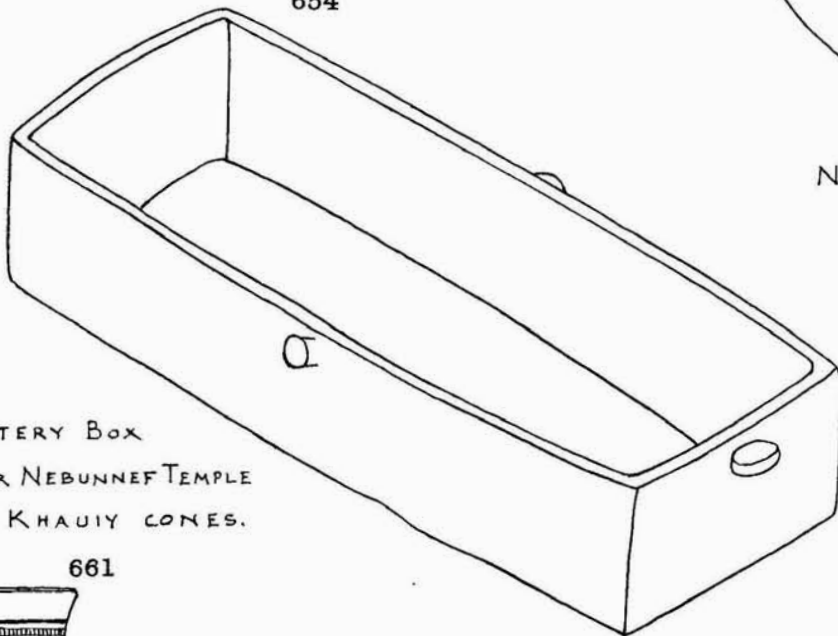

N. 7. UNDER
NEBUNNEF TEMPLE
XVIII WITH SOME LATER.

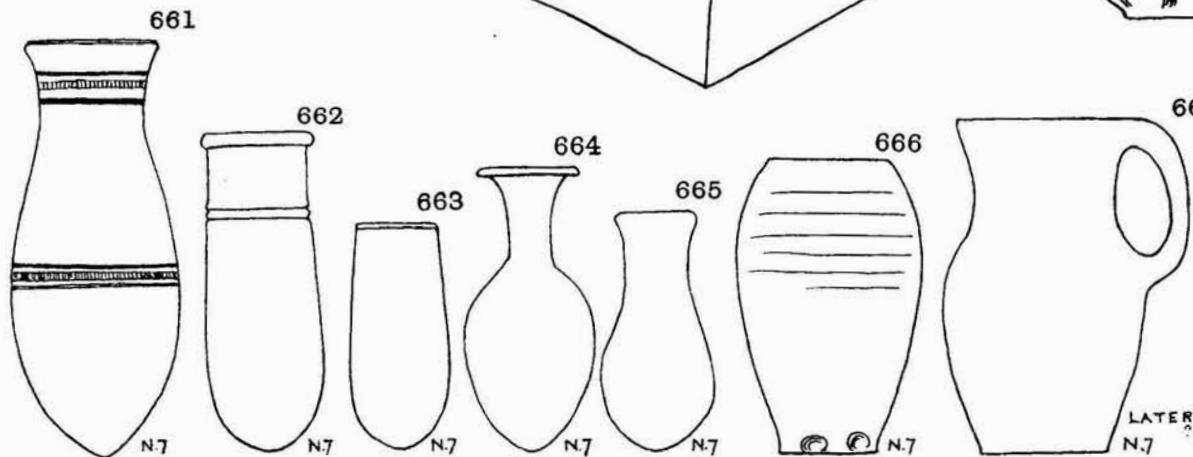

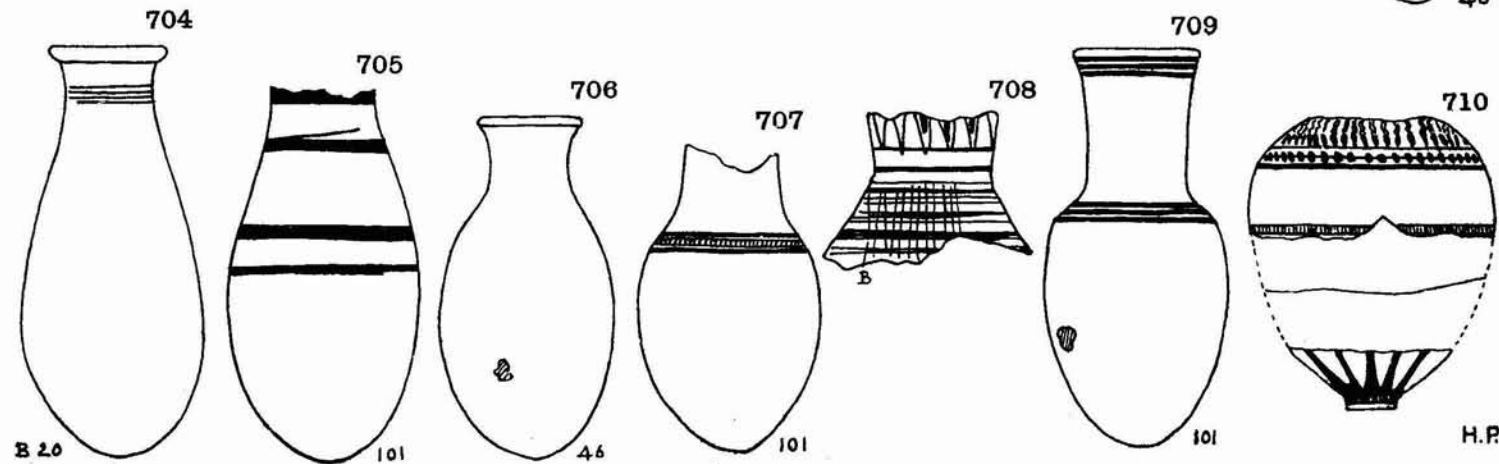
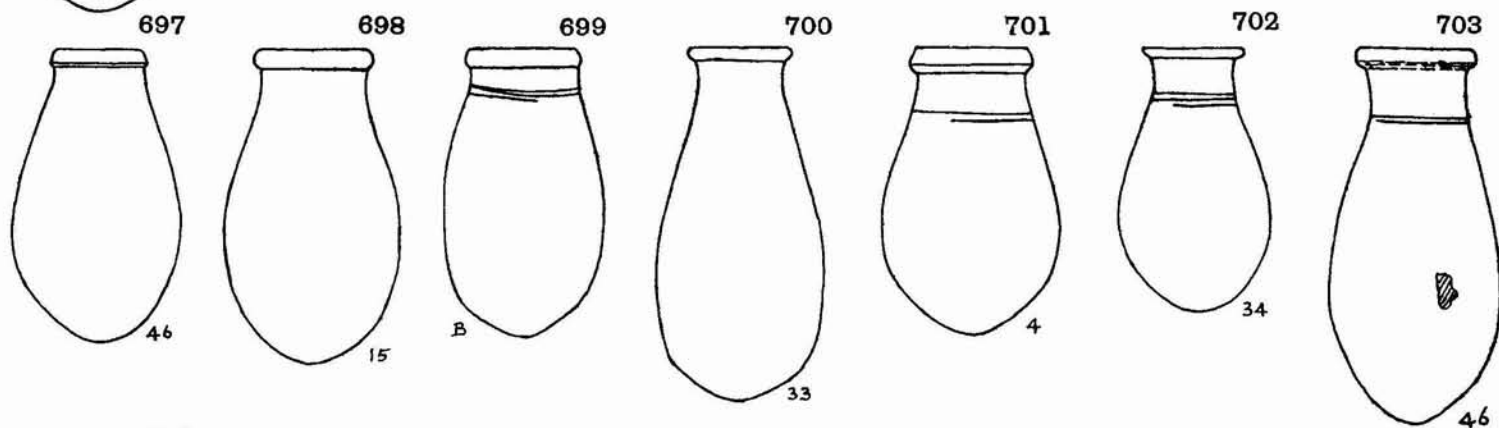
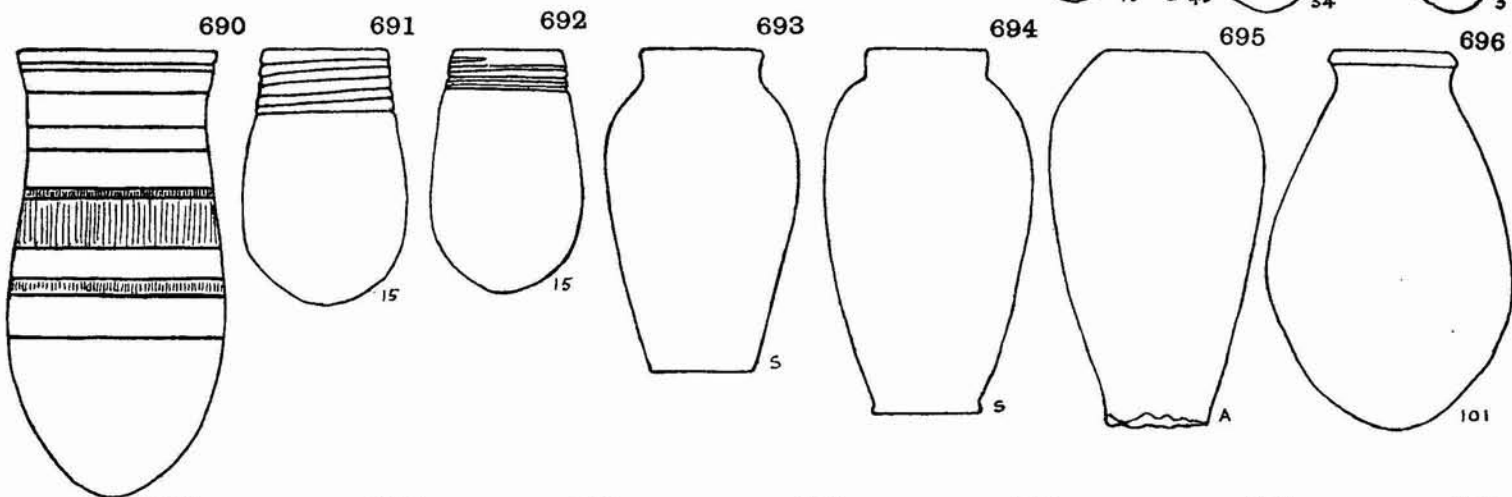
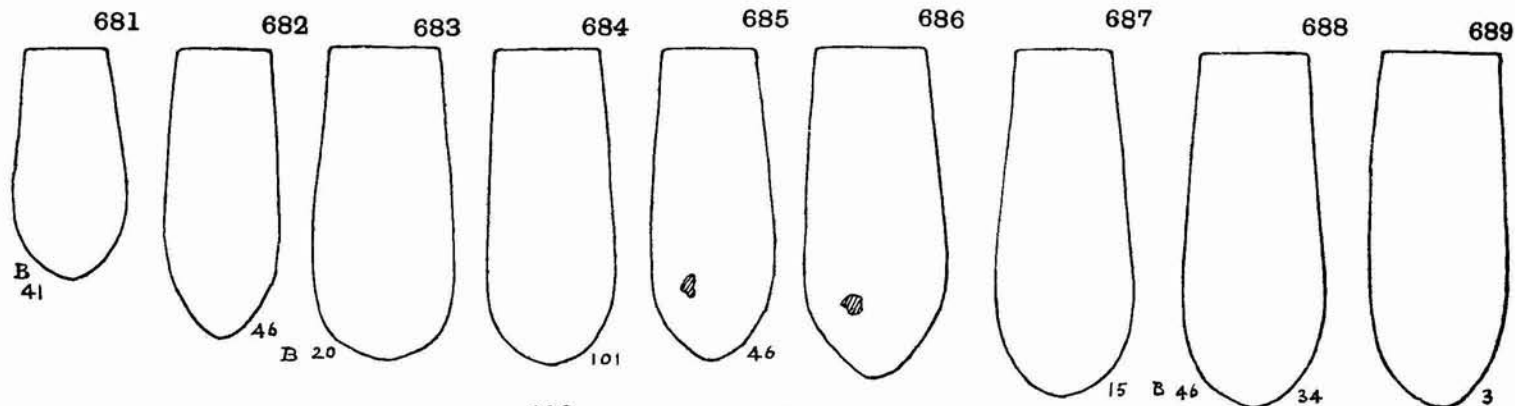
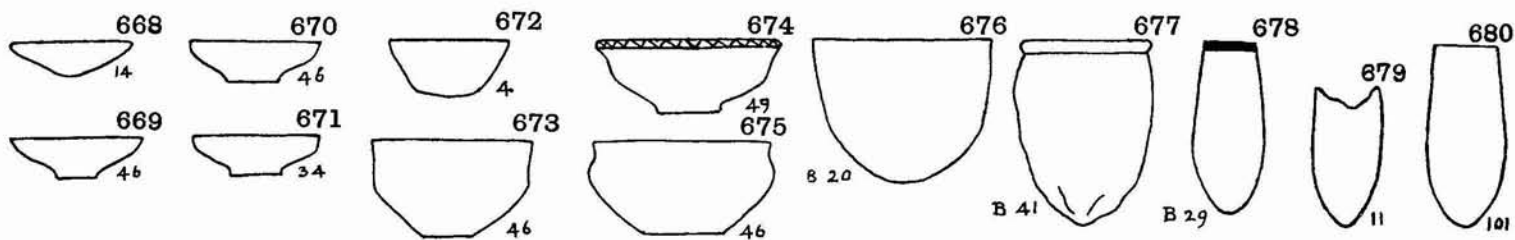

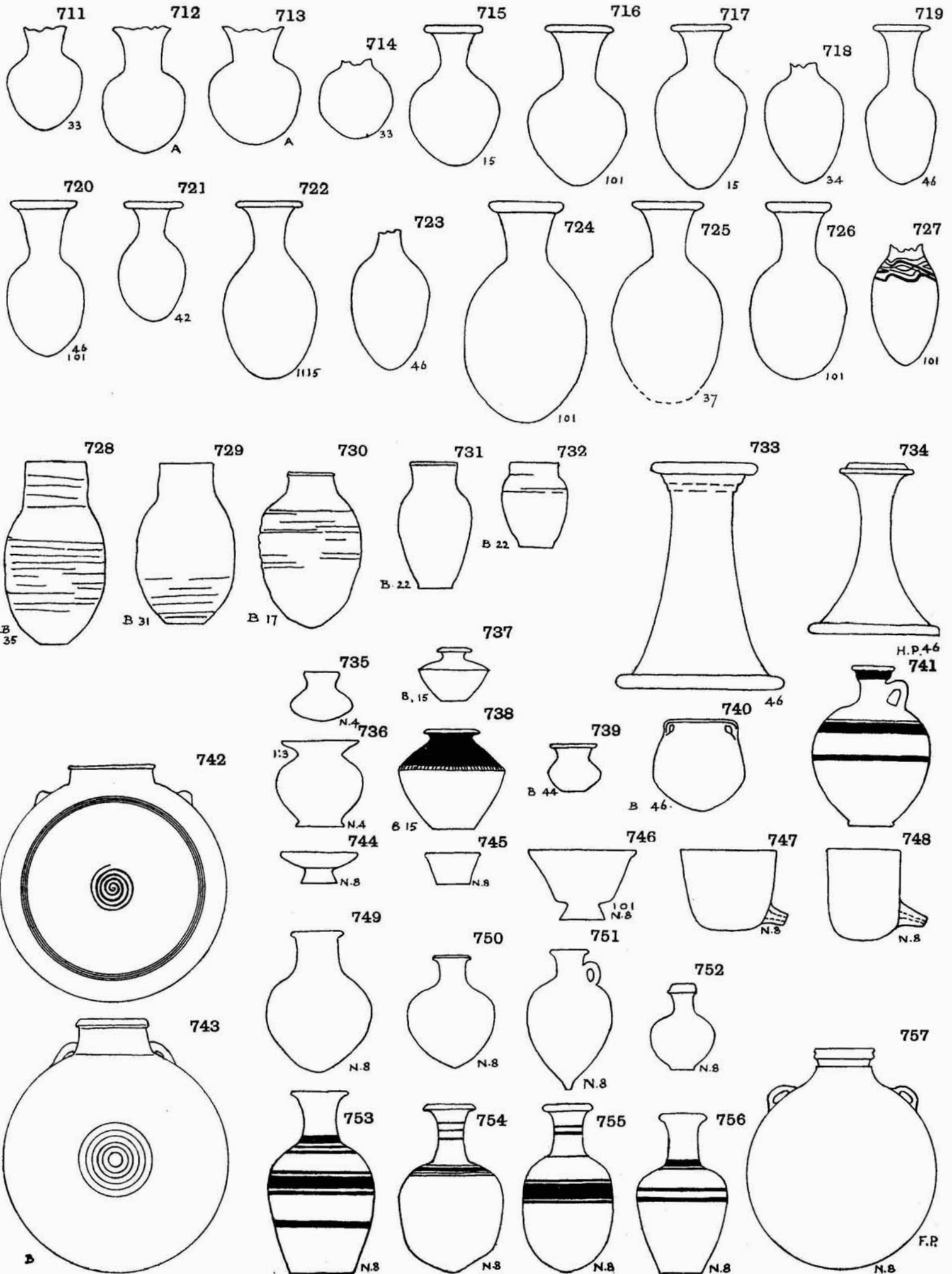

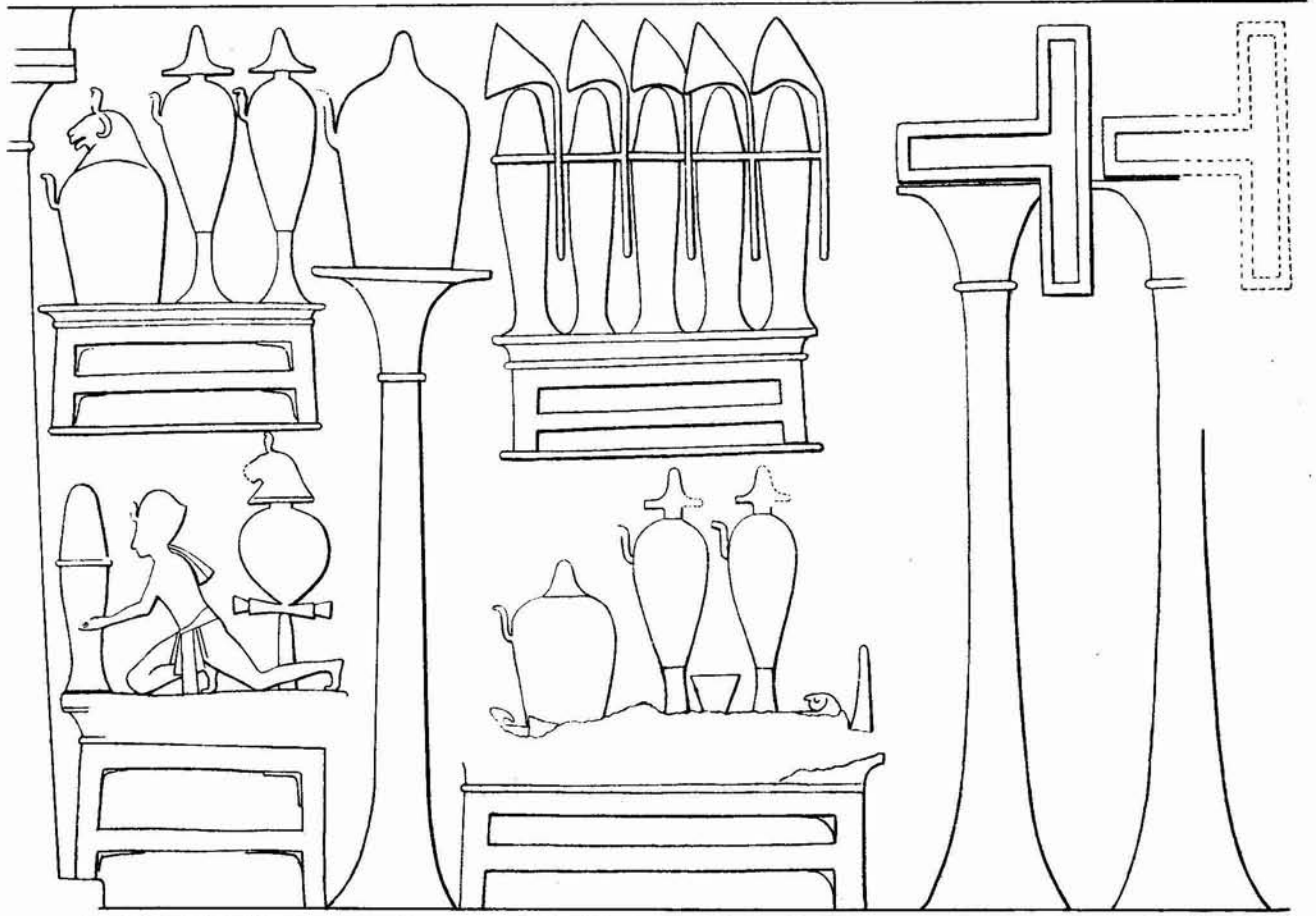
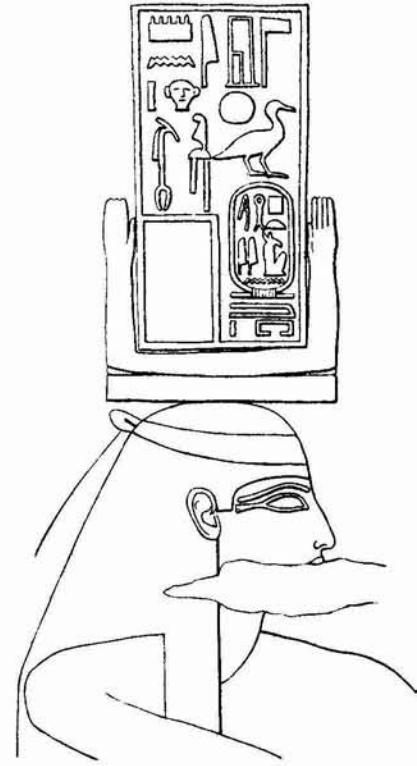
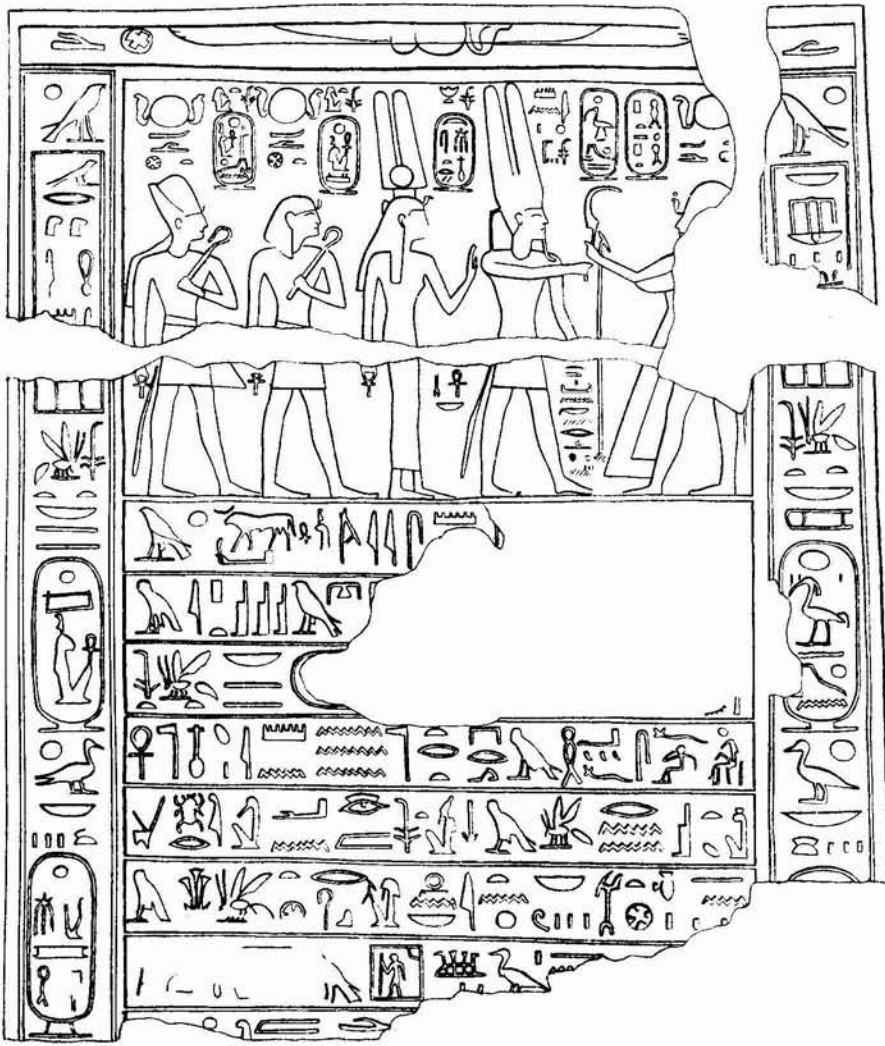

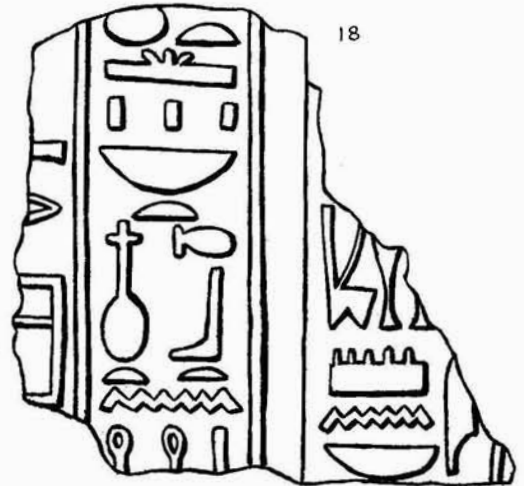
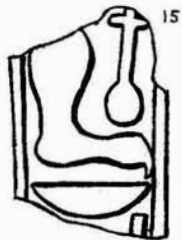
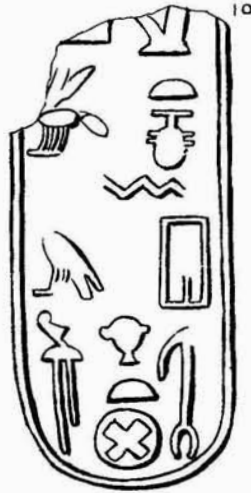
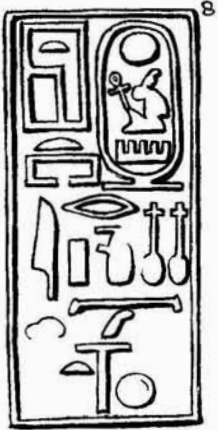

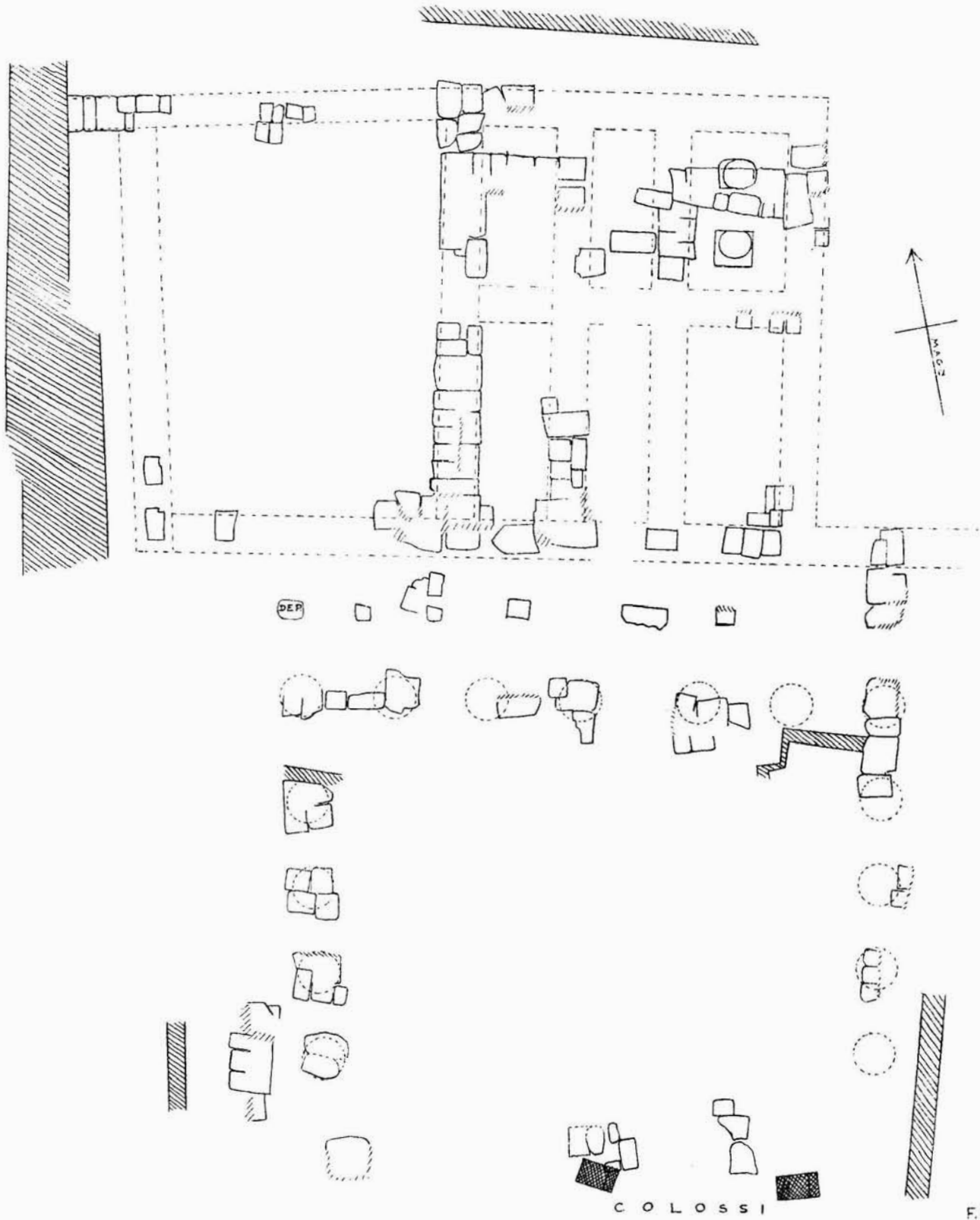



ⲓⲛⲟⲕⲓⲁⲛⲓⲏⲏ
Ⲣⲙⲟⲛⲟⲕⲟⲩⲛⲟⲩ
Ⲣⲓⲁⲛⲁⲓⲛⲓⲟⲩ
ⲙⲡⲓⲟⲩⲩⲛⲟⲙⲟⲛⲧ
ⲱⲏⲏⲗⲗⲉⲕⲱⲓⲛⲁⲩⲛⲧⲏⲩ

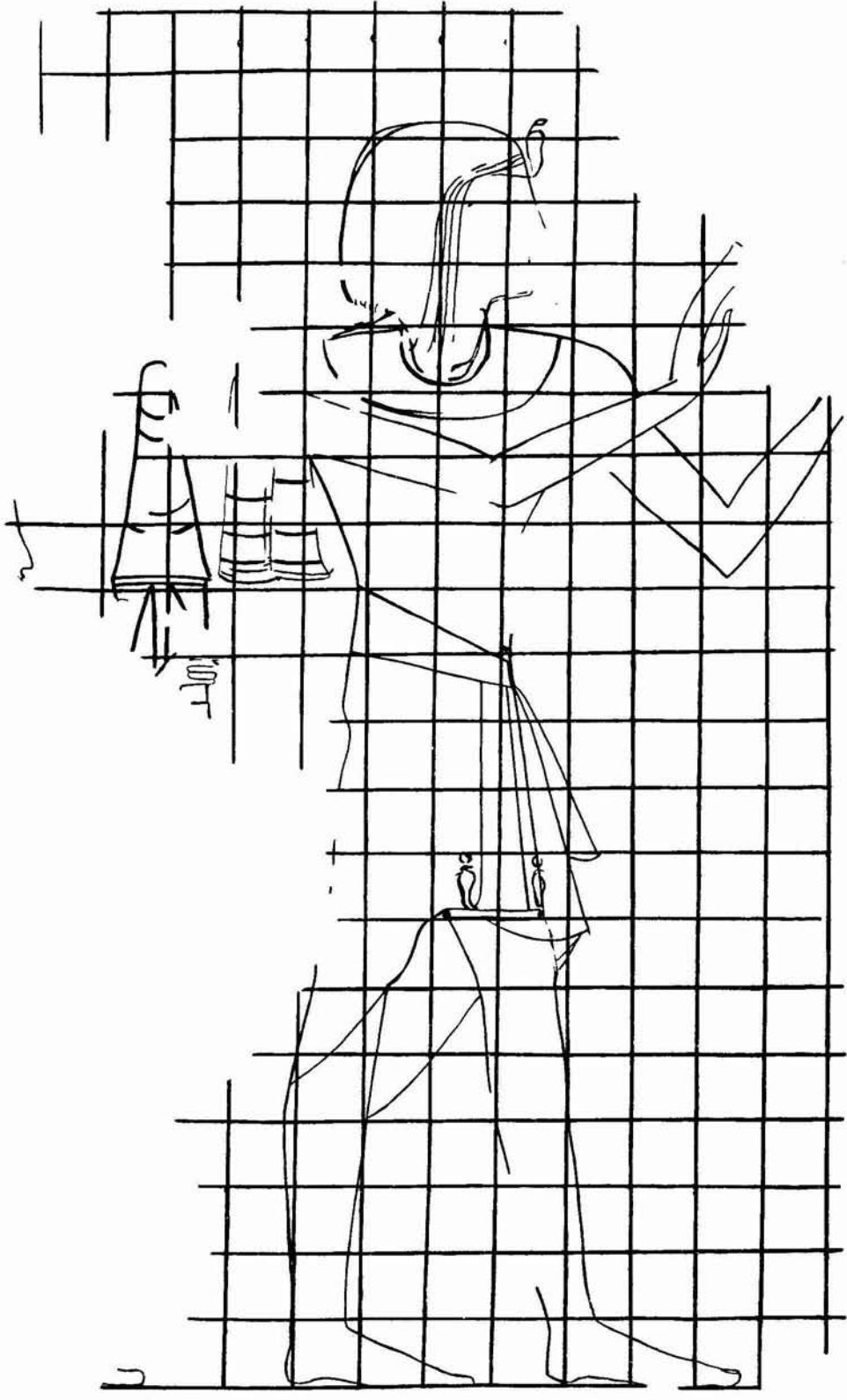
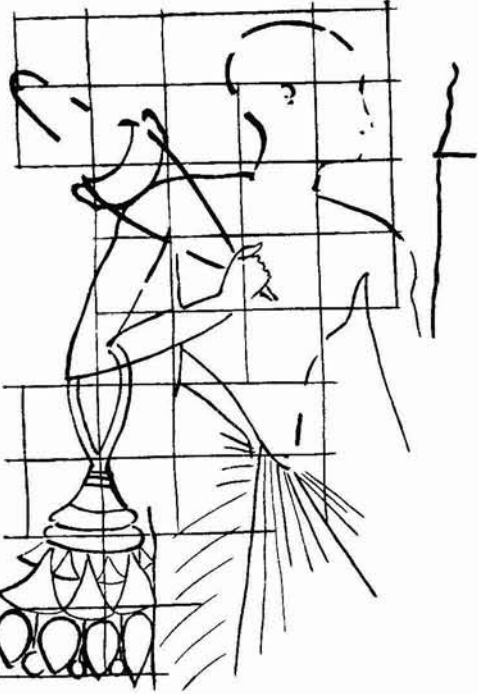

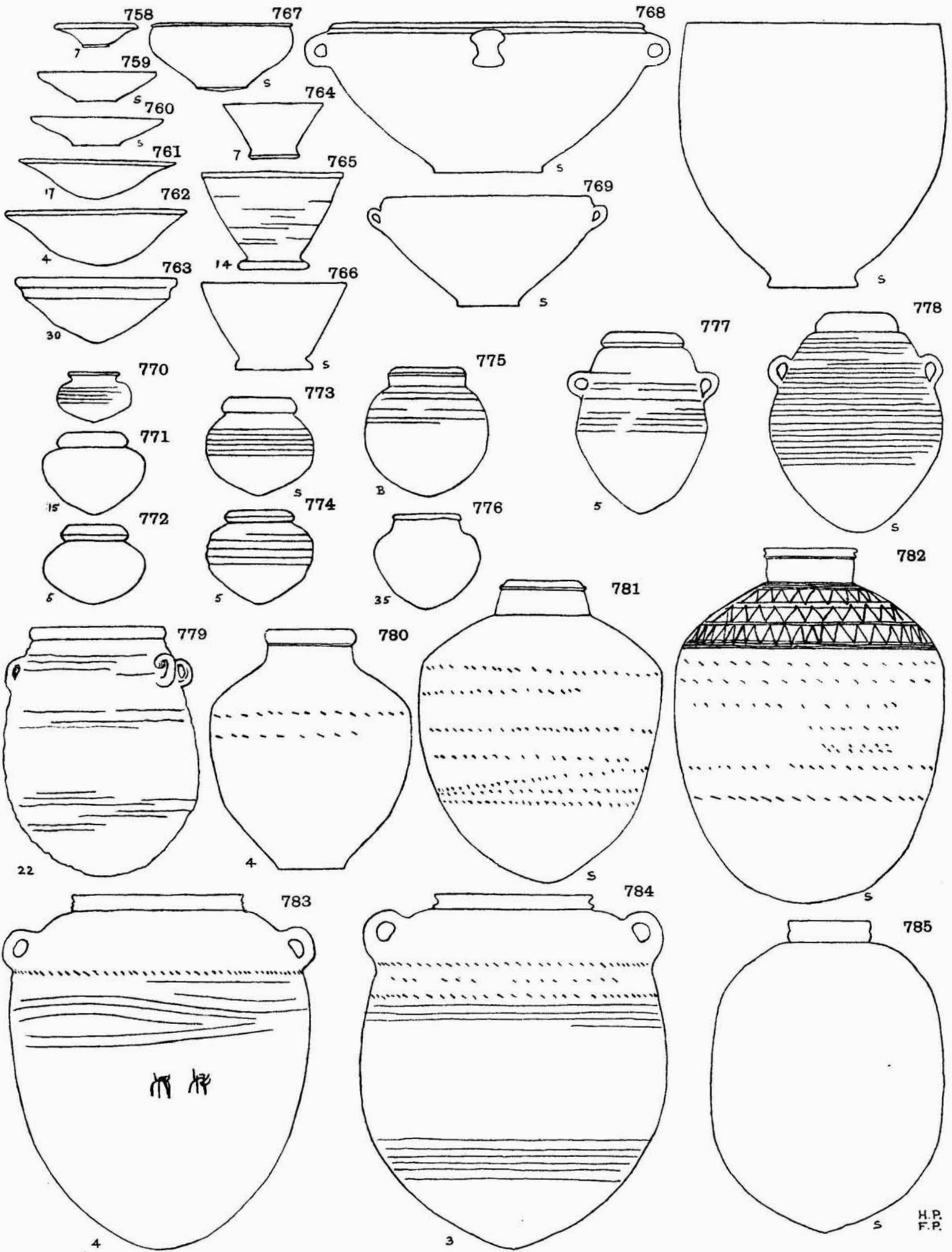

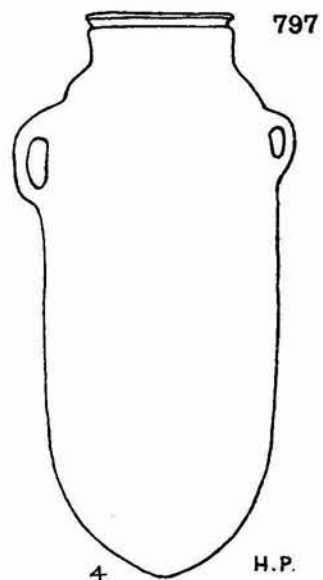
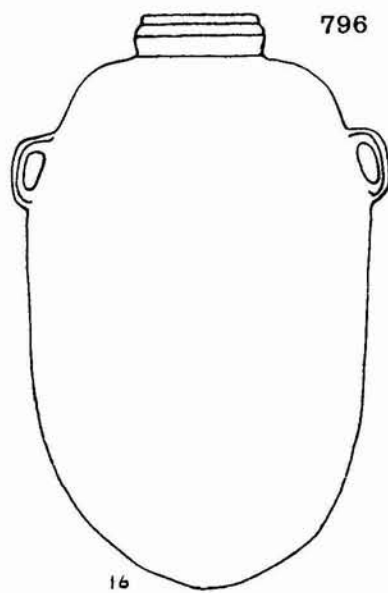
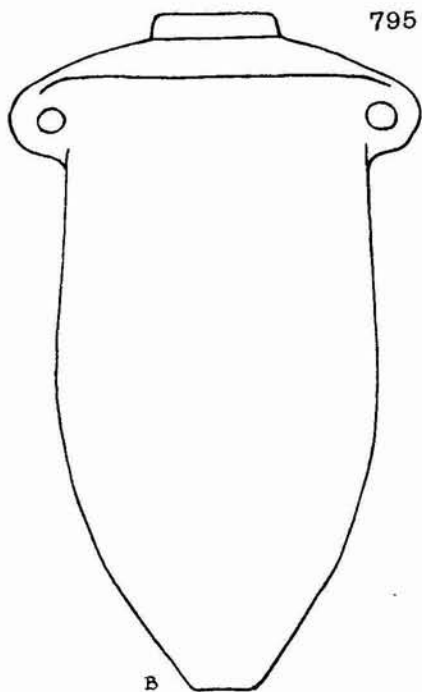
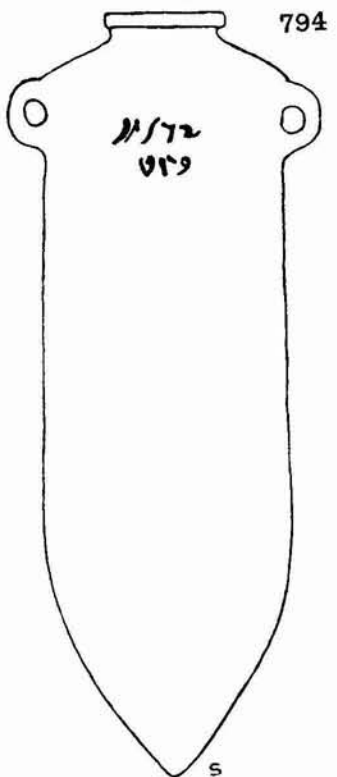
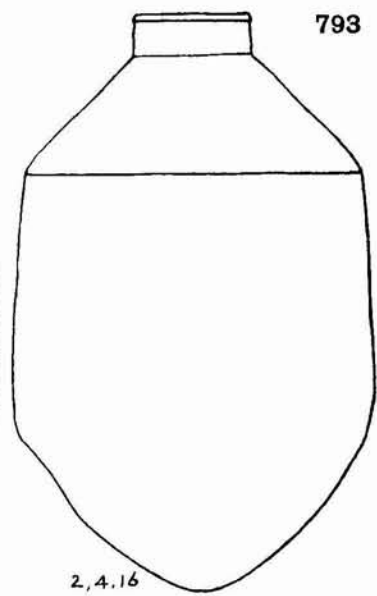
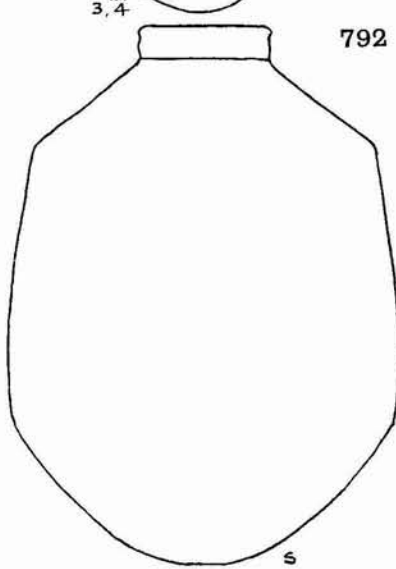
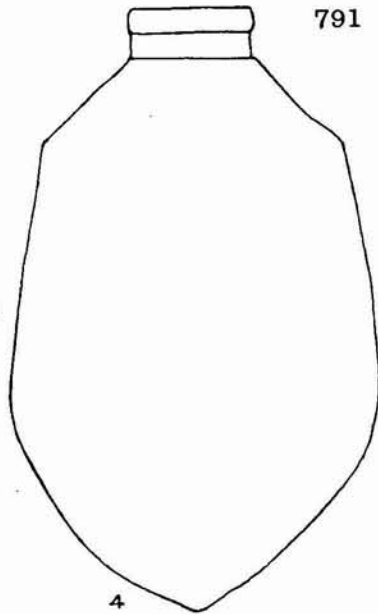
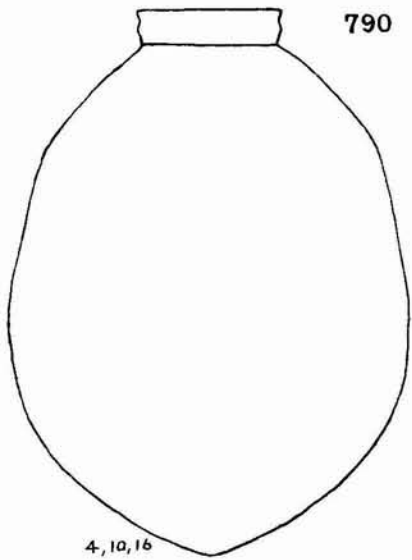
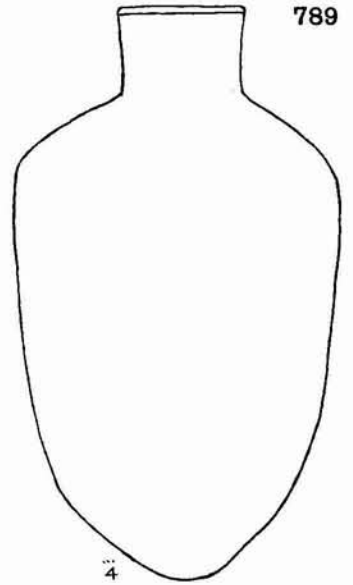
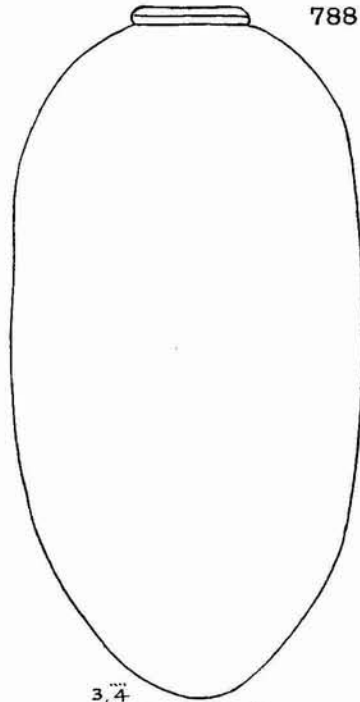
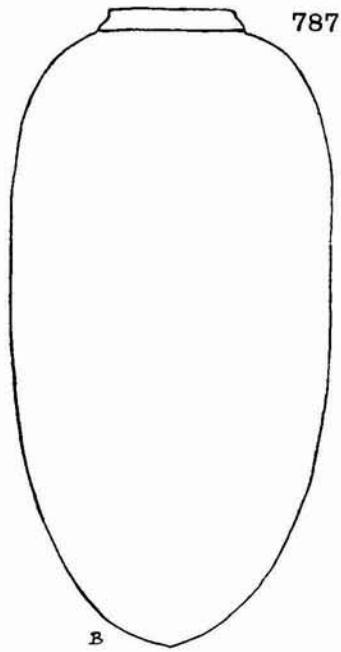
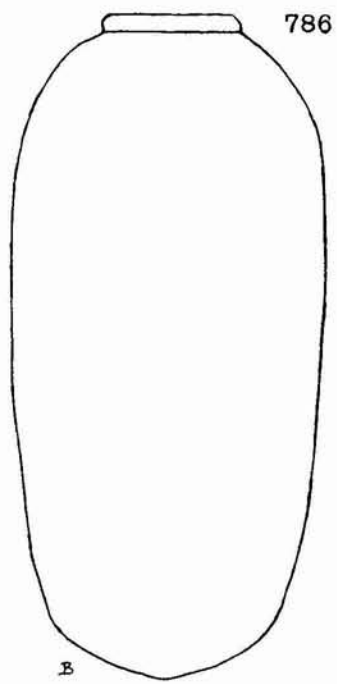

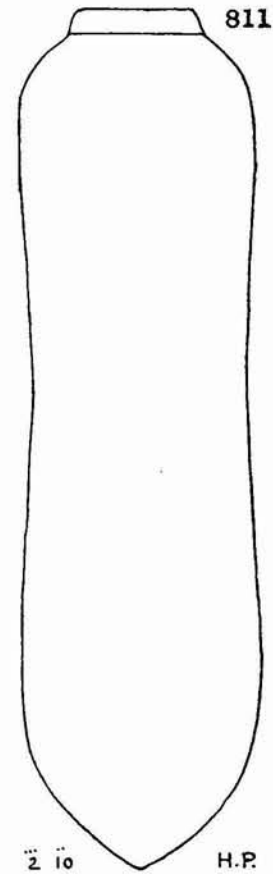
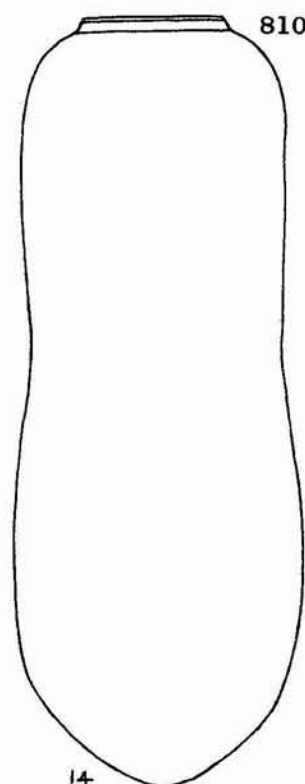
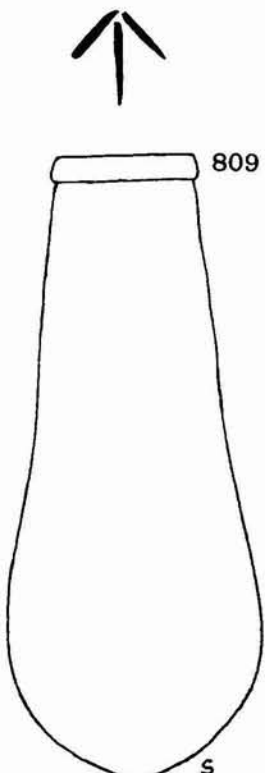
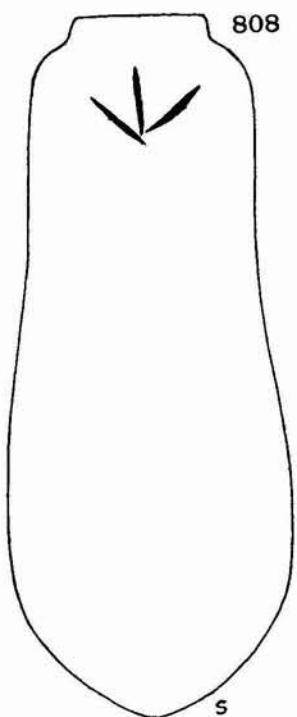
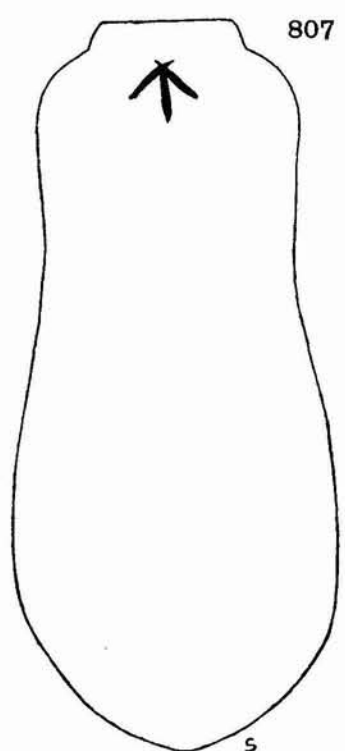
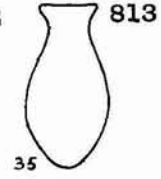
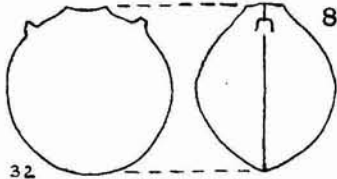
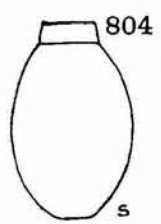
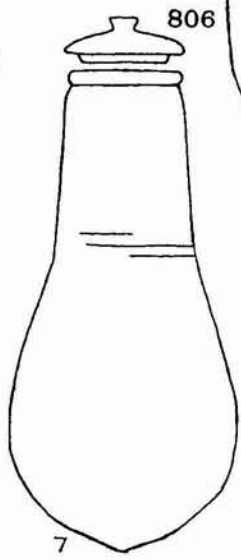
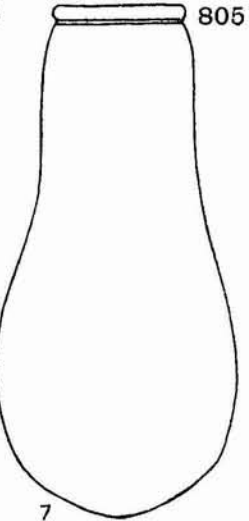
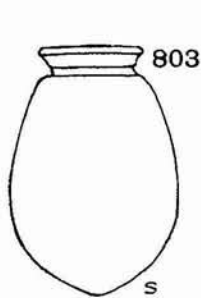
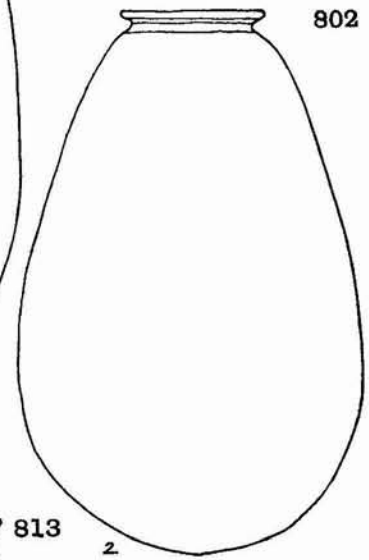
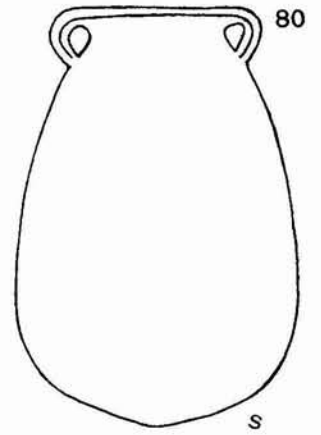
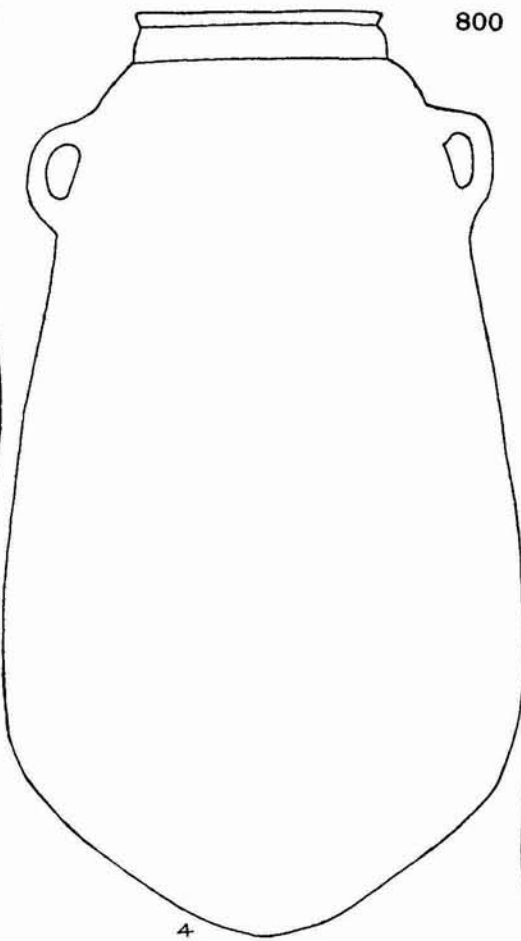
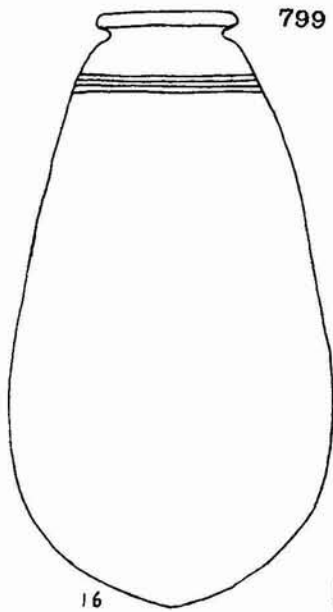
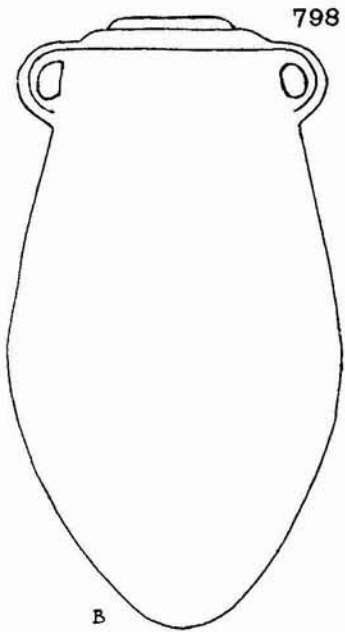

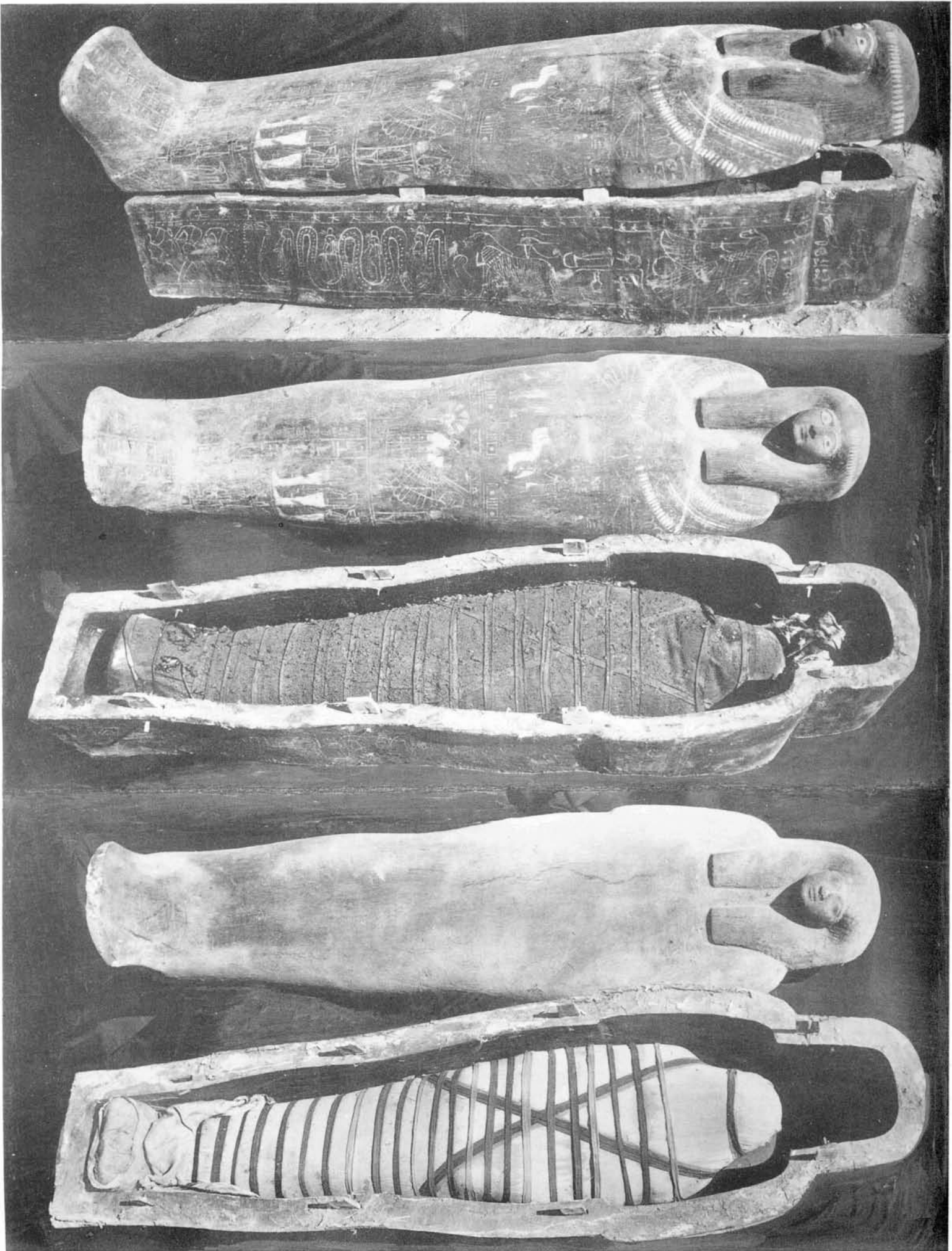



LOTUS FROM BURIAL.

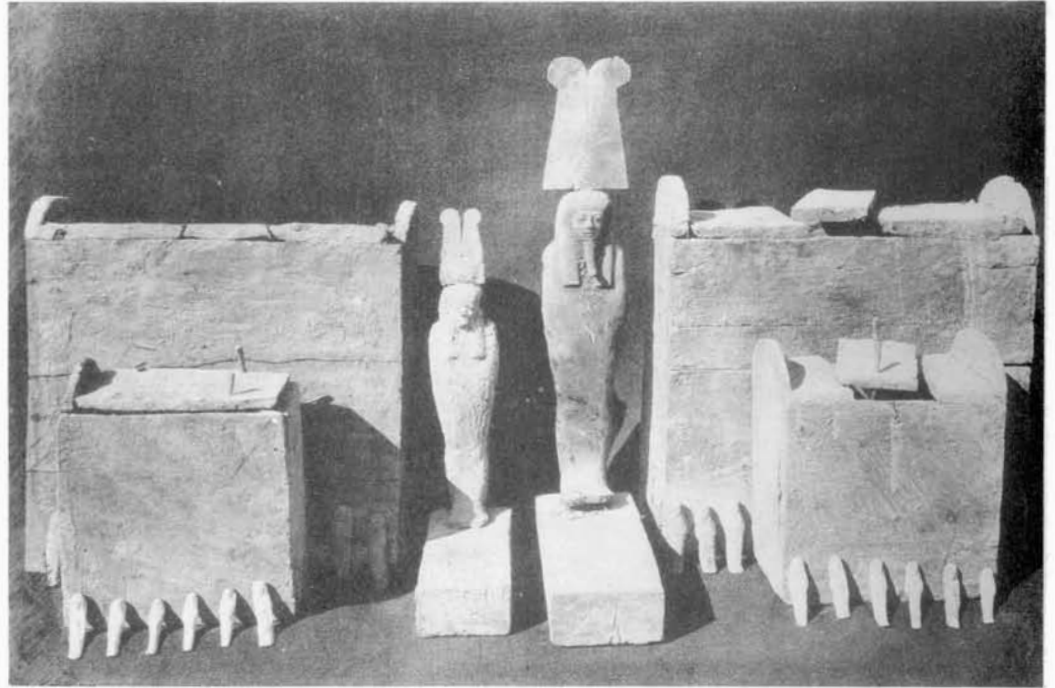

OSIRIS FIGURES, USHABTI BOXES, AND USHABTIS.



ROMAN GUARD HOUSE,
COPTIC HERMITAGE AND PILLAR
DWELLING.



PILLAR DWELLING FROM ABOVE.



MODERN SOUL HOUSES BY SHEYKH'S TOMB.

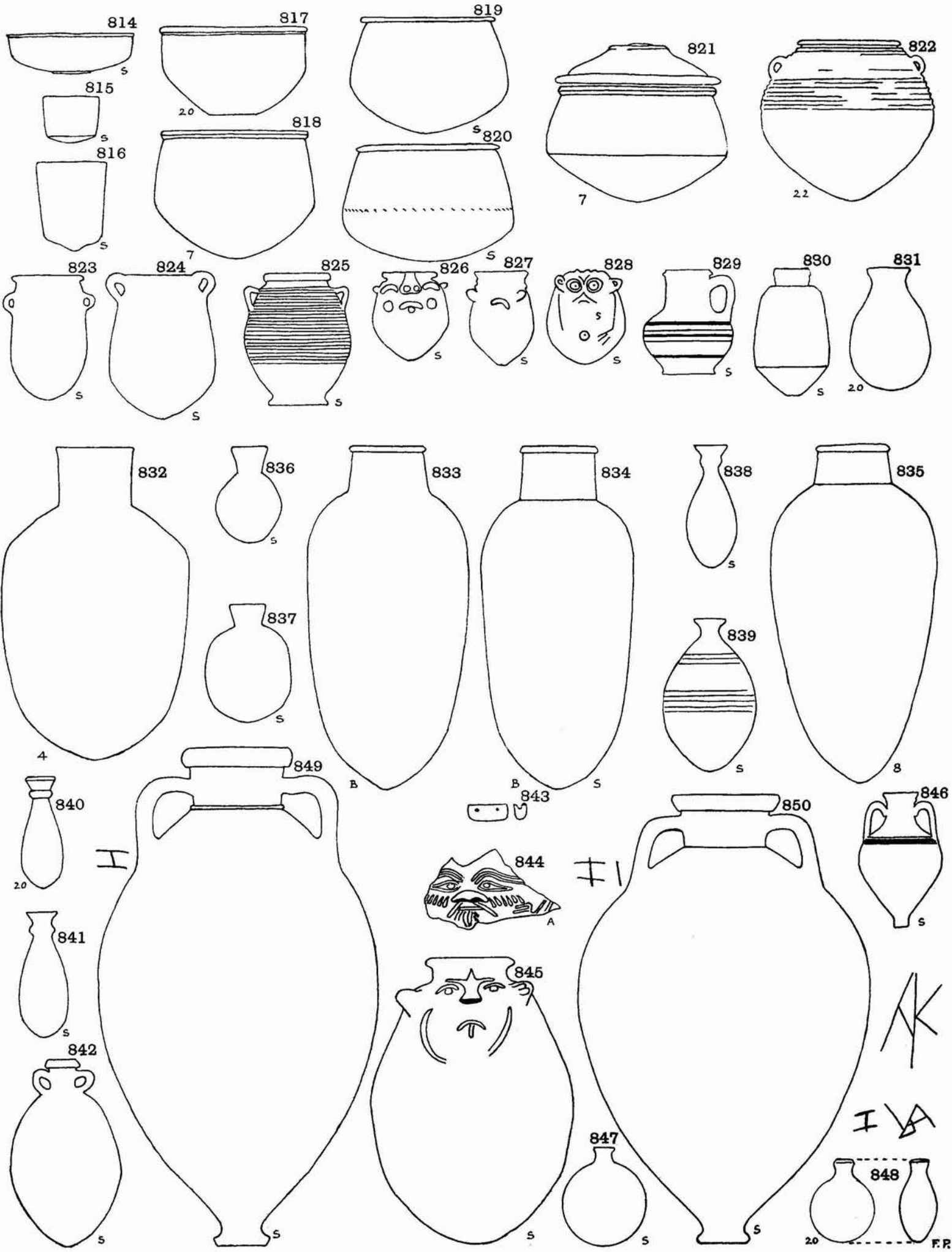

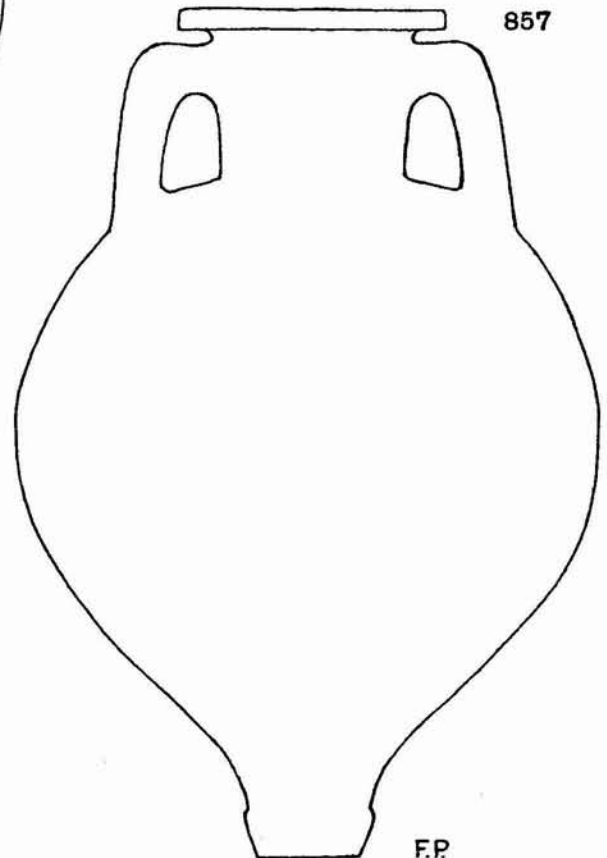
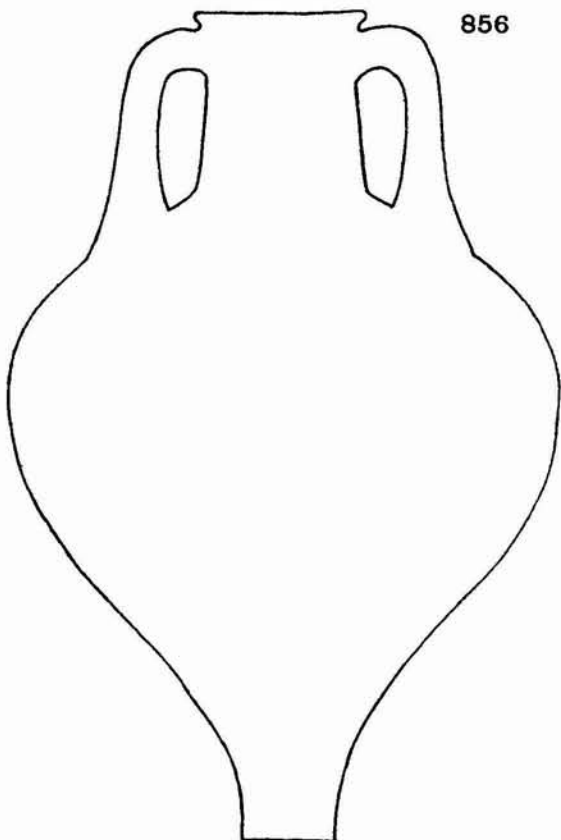
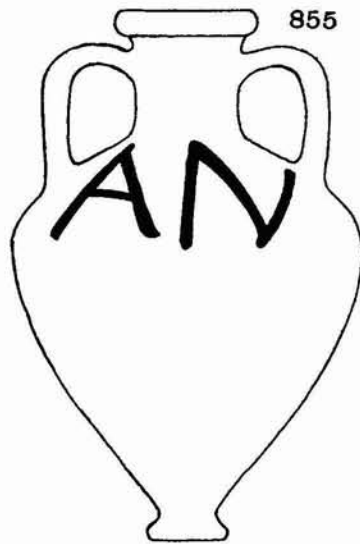
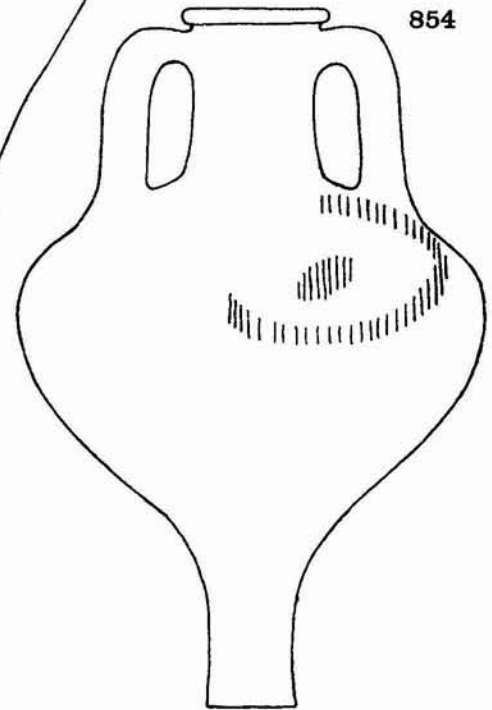
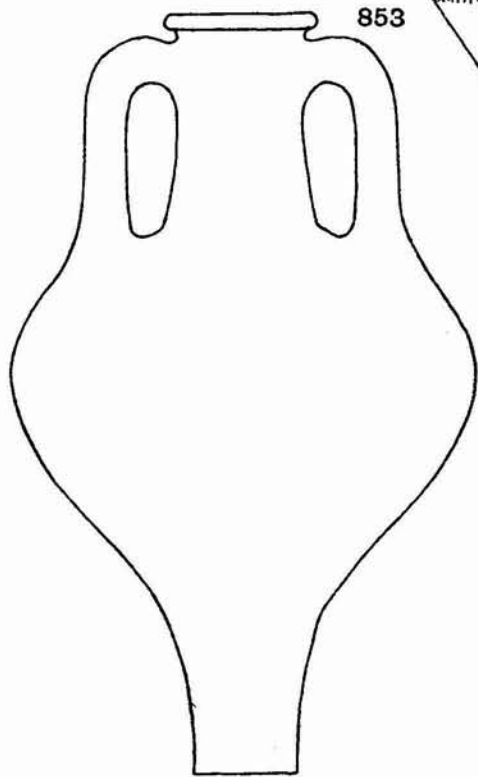
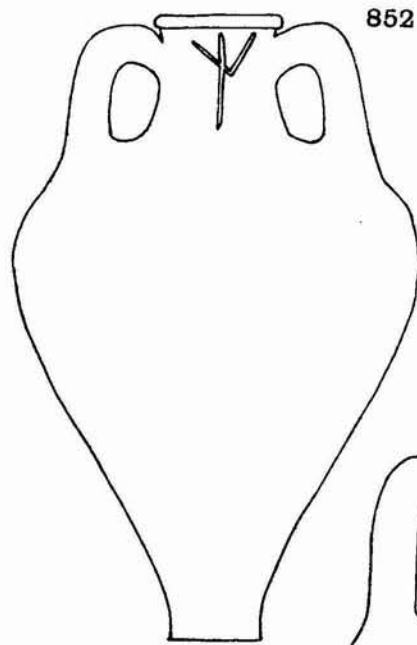
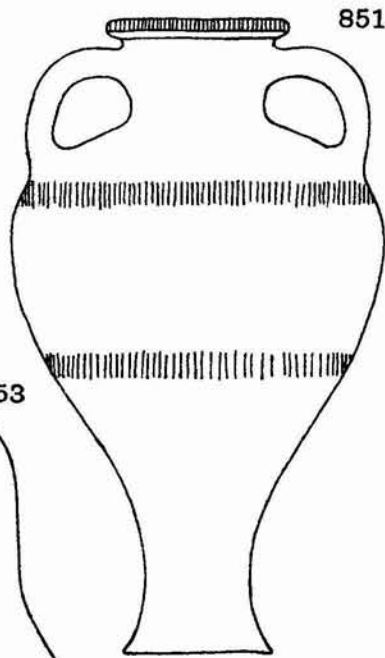

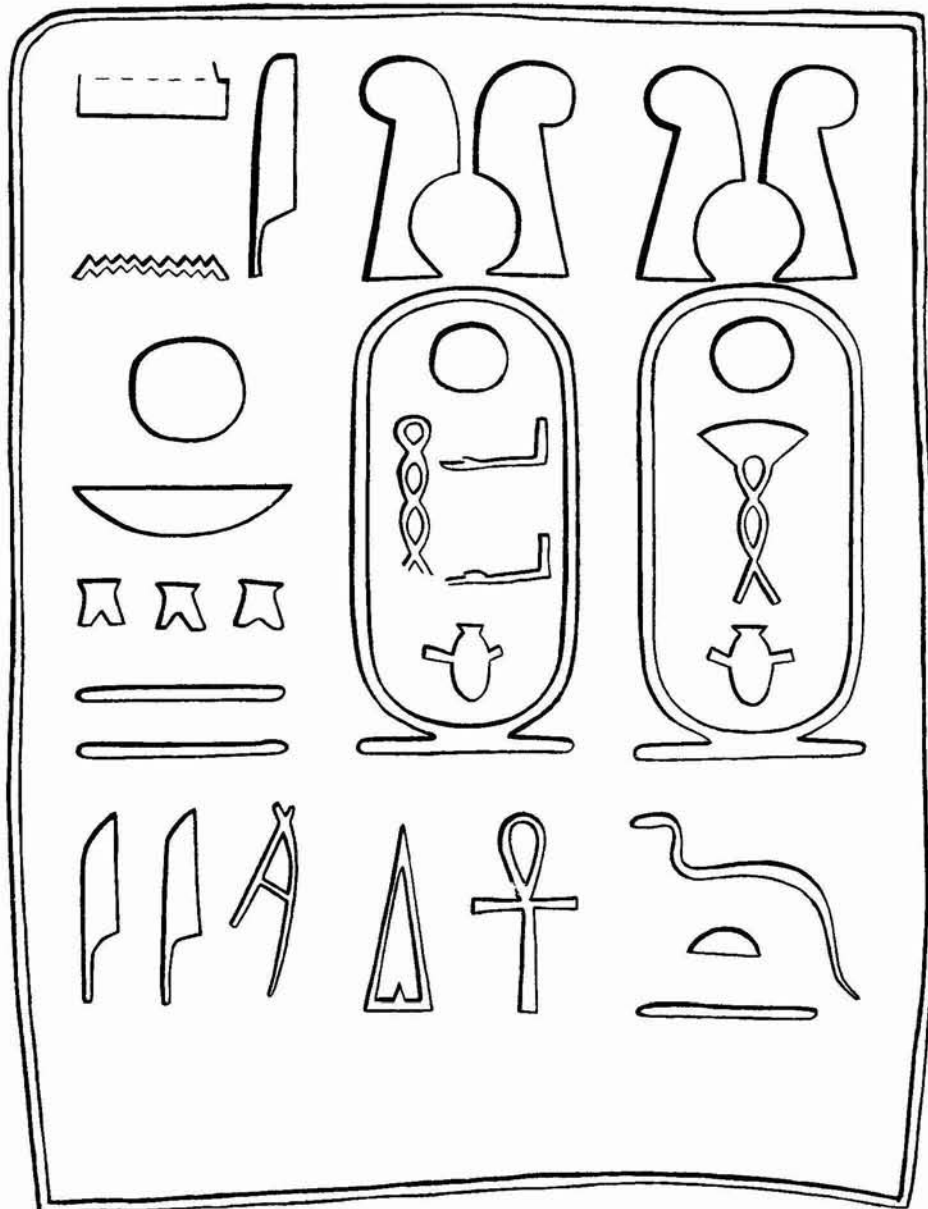

H.P.

WORKS BY W. M. FLINDERS PETRIE.

- THE PYRAMIDS AND TEMPLES OF GIZEH. (Out of print.)
- TANIS I. 19 pl., 25s. *Quaritch.*
- TANIS II. Nebesheh and Defenneh. 64 pl., 25s. *Quaritch.*
- NAUKRATIS I. 45 pl., 25s. *Quaritch.*
- HIEROGLYPHIC PAPYRUS FROM TANIS. (Out of print.)
- A SEASON IN EGYPT, 1887. 32 pl. (Out of print.)
- RACIAL PORTRAITS. 190 photographs from Egyptian Monuments, 63s. *Murray, 37, Dartmouth Park Hill, N.W.*
- HISTORICAL SCARABS. (Out of print.)
- HAWARA, BIAHMU, AND ARSINOE. (Out of print.)
- KAHUN, GUROB, AND HAWARA. (Out of print.)*
- ILLAHUN, KAHUN, AND GUROB. 33 pl., 16s. (Out of print.)*
- TELL EL HESY (LACHISH). 10 pl., 10s. 6d. *Alexander Watt.*
- MEDUM. 36 pl. (Out of print.)
- TEN YEARS' DIGGING IN EGYPT, 1881-1891. 6s. *R.T.S.*
- TELL EL AMARNA. (Out of print.)*
- KOPTOS. 28 pl., 10s. *Quaritch.*
- A STUDENT'S HISTORY OF EGYPT. Part I., down to the XVIth Dynasty. 5th ed. 1903. Part II., XVIIth and XVIIIth Dynasties. Part III., XIXth to XXXth Dynasties. 6s. each. *Methuen.*
- TRANSLATIONS OF EGYPTIAN TALES. With illustrations by Tristram Ellis. 2 vols., 3s. 6d. *Methuen.*
- DECORATIVE ART IN EGYPT. 3s. 6d. *Methuen.*
- NAQADA AND BALLAS. 86 pl., 25s. *Quaritch.*
- SIX TEMPLES AT THEBES. 26 pl., 10s. *Quaritch.*
- DESHASHEH. 37 pl., 25s. *Quaritch.*
- RELIGION AND CONSCIENCE IN EGYPT. 2s. 6d. *Methuen.*
- SYRIA AND EGYPT. 2s. 6d. *Methuen.*
- DENDEREH. 38 pl., 25s.; 40 additional plates, 10s. *Quaritch.*
- ROYAL TOMBS OF FIRST DYNASTY. 68 pl., 25s. *Quaritch.*
- DIOSPOLIS PARVA. 48 pl. (Out of print.)
- ROYAL TOMBS OF EARLIEST DYNASTIES. 63 pl., 25s.; 35 additional plates, 10s. *Quaritch.*
- ABYDOS. Part I. 81 pl., 25s. *Quaritch.*
- ABYDOS. Part II. 64 pl., 25s. *Quaritch.*
- METHODS AND AIMS IN ARCHAEOLOGY. 66 blocks, 6s. *Macmillan.*
- EHNASYA. 25s. *Quaritch.*
- ROMAN EHNASYA. 10s. *Quaritch.*
- RESEARCHES IN SINAI. 186 illustrations; and 4 plans, 21s. *John Murray.*
- HYKSOS AND ISRAELITE CITIES. 40 pl., 25s. *Quaritch.*
- RELIGION OF ANCIENT EGYPT. 1s. *Constable.*
- GIZEH AND RIFEH. 40 pl., 25s.; with 69 extra plates, 50s. *Quaritch.*
- ATHRIBIS. 43 pl., 25s. *Quaritch.*
- PERSONAL RELIGION IN EGYPT BEFORE CHRISTIANITY. 2s. 6d.; in leather, 3s. 6d. *Harper.*
- MEMPHIS. Part I. 54 pl., 25s. *Quaritch.*
- QURNEH. 56 pl., 25s. *Quaritch.*
- MEMPHIS. Part II. (*In preparation.*)
- ARTS AND CRAFTS OF ANCIENT EGYPT. 45 pl., 5s. *Foulis. (In preparation.)*

PUBLICATIONS

OF THE

EGYPTIAN RESEARCH ACCOUNT

- I. BALLAS, 1895; by J. E. QUIBELL. (Out of print; obtainable in joint volume NAQADA AND BALLAS, by W. M. F. PETRIE.)
 - II. THE RAMESSEUM, 1896; by J. E. QUIBELL. (Out of print.)
 - III. EL KAB, 1897; by J. E. QUIBELL.
 - IV. HIERAKONPOLIS I, 1898; text by W. M. F. P. 43 plates. 20s. net.
 - V. HIERAKONPOLIS II, 1899; by F. W. GREEN and J. E. QUIBELL. 39 plates (4 coloured and 20 photographic). 35s. net.
 - VI. EL ARABAH, 1900; by J. GARSTANG. 40 plates. 16s. net. (Out of print.)
 - VII. MAHASNA, 1901; by J. GARSTANG and KURT SETHE. 43 plates. 20s. net. (Out of print.)
 - VIII. TEMPLE OF THE KINGS, 1902; by A. ST. G. CAULFEILD. 24 plates. 16s. net. (Out of print.)
 - IX. THE OSIREION, 1903; by MARGARET A. MURRAY. 37 plates. 21s. net. (Out of print.)
 - X. SAQQARA MASTABAS I, 1904; by M. A. MURRAY; AND GUROB, by L. LOAT. 64 plates. 30s. net.
 - XI. SAQQARA MASTABAS II, 1905; by HILDA PETRIE. (*In preparation.*)
 - XII. HYKSOS AND ISRAELITE CITIES, 1906; by W. M. FLINDERS PETRIE and J. GARROW DUNCAN. 40 plates. 25s. net. In double volume with 94 plates. 45s. net. (This latter out of print.)
 - XIII. GIZEH AND RIFEH, 1907; by W. M. FLINDERS PETRIE. 40 plates. 25s. net. In double volume with 109 plates. 50s. net.
 - XIV. ATHRIBIS, 1908; by W. M. FLINDERS PETRIE, J. H. WALKER and E. B. KNOBEL. 43 plates. 25s. net.
 - XV. MEMPHIS I, 1908; by W. M. FLINDERS PETRIE and J. H. WALKER. 54 plates. 25s. net.
 - XVI. QURNEH, 1909; by W. M. FLINDERS PETRIE and J. H. WALKER. 56 plates. 25s. net.
 - XVII. MEMPHIS II, 1909. (*In preparation.*)
-

Subscriptions of One Guinea for the Annual Single Volumes, or Two Guineas for the Two Annual Volumes, are received by the Hon. Secretary, at the Edwards Library, University College, Gower Street, London, W.C., where also copies of the above works can be obtained.